

Mini slides DGST

FESTO

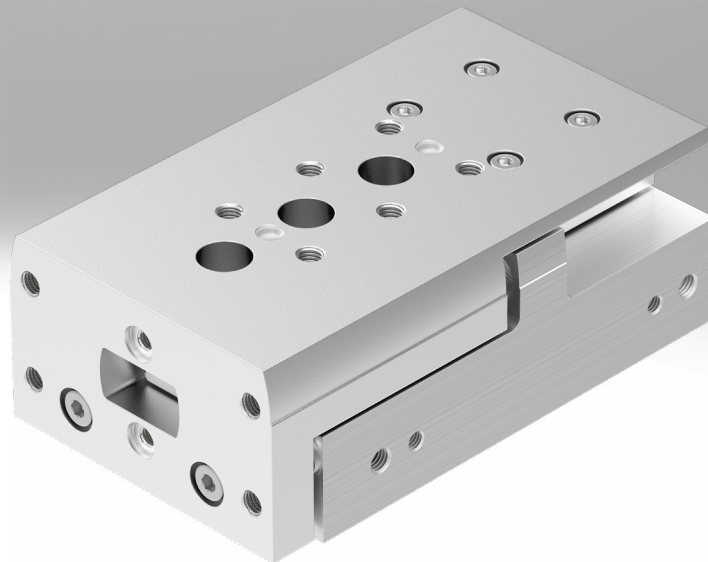

Festo Core Range
Solves the majority of your automation tasks

Worldwide:
Simply good:
Fast:

Quickest delivery – wherever, whenever
Expected high Festo quality
Easy and fast to select

With the Festo Core Range, we have selected the most important products and functions from our broad product catalogue, and added the quickest delivery.
The Core Range offers you the best value for your automation tasks.

Just look
for the
star!

Characteristics

At a glance

- Compact mini slide
- Slide and yoke plate as a single component
- Excellent price/performance ratio
- High feed forces
- Symmetrical mounting interfaces
- Precise and resilient roller bearing guide
- Simple design with symmetrical mounting interfaces
- Can be operated without additional cushioning components

The technology in detail

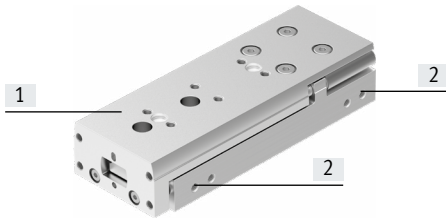

[1] Slide and yoke plate



- Slide and yoke plate as a single component, ensuring very high rigidity, precision and alignment



[2] Compressed air supply ports

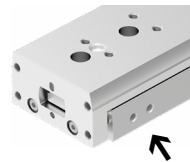

- All connections on one side

[3] Sensor slots for sensing the slide position

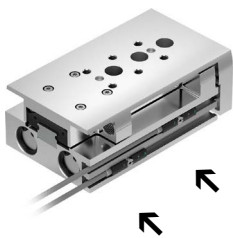

- Proximity sensors can be integrated, so there are no projecting parts
- Both end positions can be sensed from one side
- Two sensor slots for sensing

[4] Cushioning and precision end-position adjustment

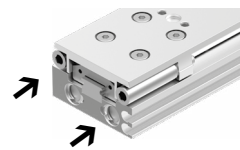

- Choice of three cushioning types:
 - Elastic cushioning at both ends, without end-position adjustment (E1)
 - Elastic cushioning at both ends, non-adjustable, with end-position adjustment (P)
 - Shock absorber at both ends, self-adjusting, with end-position adjustment (Y12)
- Precision end-position adjustment is possible from one side

[5] Twin-piston drive

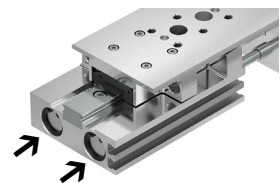

- Theoretical force at 6 bar: 34 ... 590 N
- Max. payload: 0.7 ... 17 kg

[6] Backlash-free piston rod/yoke connection

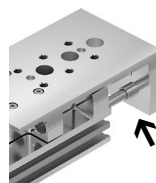

- Enhanced precision
- Longer service life

Version

[L] Mirror-inverted



- Position of the supply ports and sensor slots is mirror-inverted

Installation example

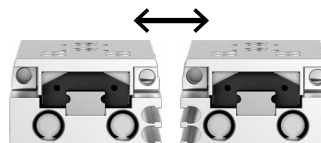

- Space-saving mounting of mini-slides next to one another

Characteristics

Axial supply ports via connection set

→ Page 46

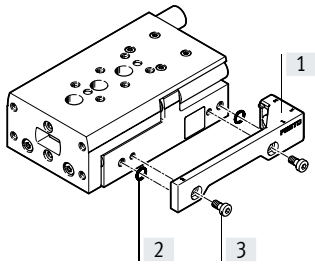

- The connection set facilitates axial supply ports
- Particularly suitable for applications in which no space is available at the side for supply ports

- [1] Connection set DADG-AK-G8-...
 [2] Seals
 [3] Screws

Areas of application

Mainly in industry segments such as:

- Electronics and light assembly
- Machine building
- Handling technology

Examples:

- Pick & Place handling units
- Piggyback handling units
- Precise positioning
- Precise press-fitting

Application examples

Pick & Place handling unit

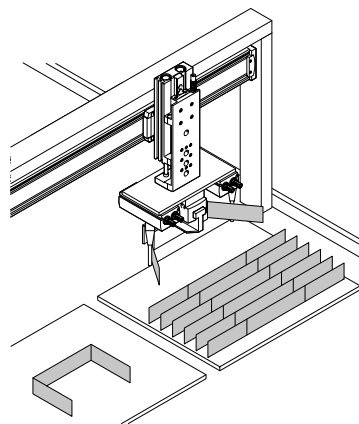
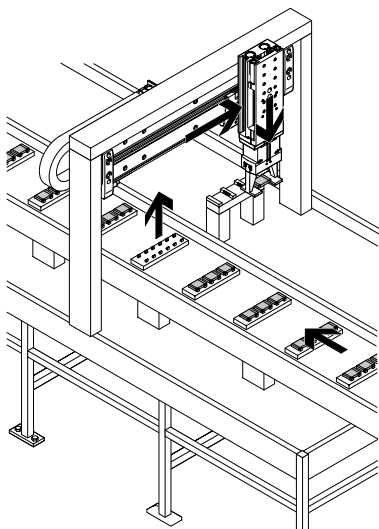

Precise positioning

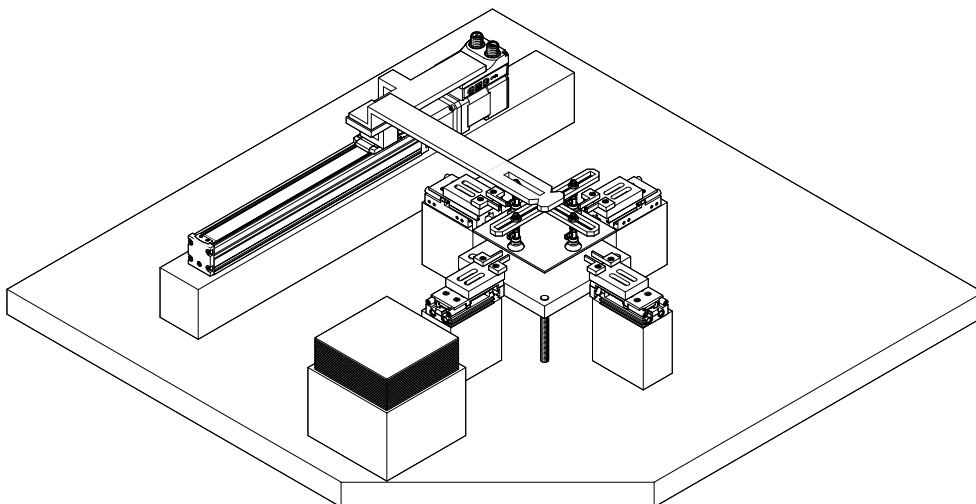

Characteristics

Possible combinations of pick & place applications without adapter plate

Sizes 6 to 8

Other combinations

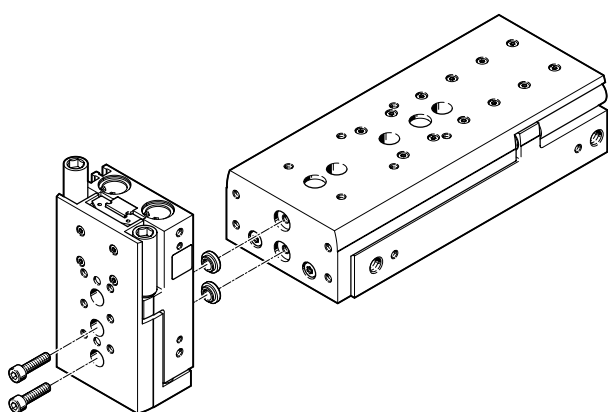
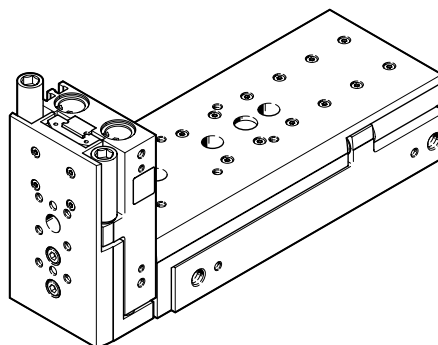
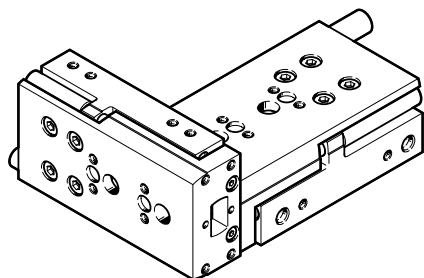

	[1] Basic drive							
	Size	6	8	10	12	16	20	25
[2] Add-on drive	6	–	2x M3x14 2x ZBH-5	2x M3x14 2x ZBH-5	–	–	–	–
	8	–	–	2x M3x18 2x ZBH-5	–	–	–	–
	10	–	–	–	2x M4x22 2x ZBH-7	2x M4x22 2x ZBH-7	–	–
	12	–	–	–	–	2x M4x27 2x ZBH-7	–	–
	16	–	–	–	–	–	2x M5x30 2x ZBV-12-9	–
	20	–	–	–	–	–	–	2x M6x40 2x ZBH-12

Note
The mounting components are not included in the scope of delivery of the mini slide.

For manufacturing lithium-ion batteries

DGST...-F1A

Recommended for production plants for manufacturing lithium-ion batteries (Cu<=1%, Zn<=1%, Ni<=1%).
Metals with copper, zinc or nickel as the main constituent are excluded from use. Exceptions are nickel in steels, chemically nickel-plated surfaces, printed circuit boards, cables, electrical plug connectors and coils.

Accessories

Your Festo contact partner can provide information about which accessories are suitable for manufacturing lithium-ion batteries.

Type codes

001	Series
DGST	Slide drive

002	Size
6	6
8	8
10	10
12	12
16	16
20	20
25	25

003	Stroke
10	10
20	20
30	30
40	40
50	50
80	80
100	100
125	125
150	150
200	200

004	Version
	Standard
L	Mirror-inverted

005	Cushioning
P	Elastic cushioning rings/plates on both sides
Y12	Shock absorber, self-adjusting, linear at both ends, external
E1	Elastomer cushioning, double-sided, stroke not adjustable

006	Position sensing
A	For proximity sensor

007	Special material properties
	None
F1A	Recommended for production facilities for the manufacture of lithium-ion batteries (Cu<=1%, Zn<=1%, Ni<=1%)

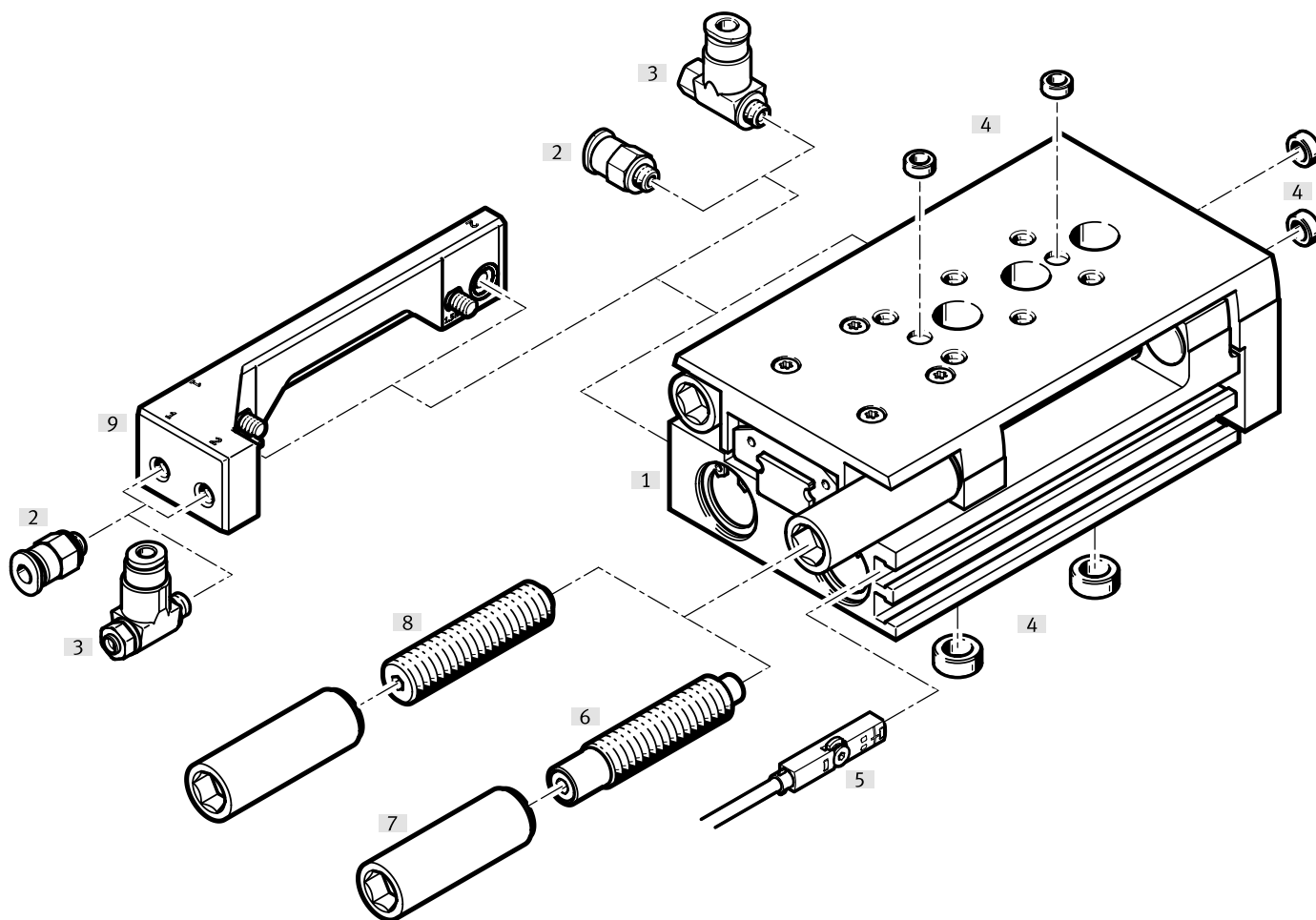

Peripherals overview

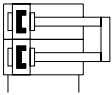

Accessories	Description	→ Page/Internet
[1] Mini slide DGST	Compact design	7
[2] Push-in fitting QSM	For connecting compressed air tubing with standard O.D.	49
[3] One-way flow control valve GRLA	For regulating speed	49
[4] Centring sleeve ZBH	<ul style="list-style-type: none"> • For centring loads and attachments • (Centring sleeves not included in the scope of delivery of the mini slide) 	49
[5] Proximity switch SMT-10/-8	For position sensing. Can be integrated in the sensor slot, so there are no projecting parts	50
Position transmitters SMAT-8M, SDAT	<ul style="list-style-type: none"> • Analogue position feedback possible • Choice of analogue output: 0 ... 10 V, 0 ... 20 mA 	51
[6] Cushioning Y12	Shock absorber at both ends, self-adjusting, with end-position adjustment	48
[7] Threaded sleeve	<ul style="list-style-type: none"> • For mounting the cushioning components • Included in the scope of delivery for cushioning [5]/[6] 	49
[8] Cushioning P	Elastic cushioning at both ends, non-adjustable, with end-position adjustment	48
[9] Connection set DADG-AK-G8	For axial connection of compressed air tubing	46

Data sheet



-  Size
6 ... 25
-  Stroke length
10 ... 200 mm

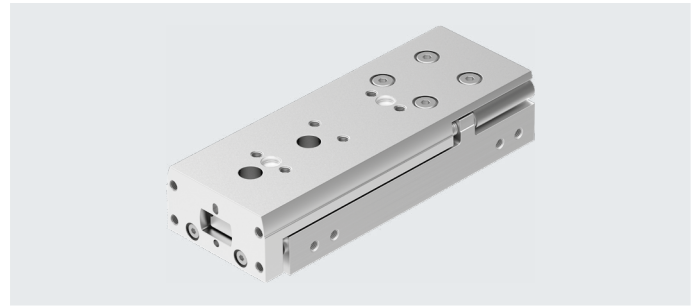

General technical data		6	8	10	12	16	20	25	
Size		6	8	10	12	16	20	25	
Design		Twin piston, piston rod, slide, yoke							
Guide		Recirculating ball bearing guide					Three-part cage guide		
Mode of operation		Double-acting							
Type of mounting		Via through-hole Via female thread							
Pneumatic connection		M3	M5				G1/8		
Stroke ¹⁾	[mm]	10 ... 50	10 ... 80	10 ... 100	10 ... 100	10 ... 150	10 ... 200	10 ... 200	
Cushioning									
DGST...-E1		Elastic cushioning at both ends, without end-position adjustment							
DGST...-P		Elastic cushioning at both ends, non-adjustable, with end-position adjustment							
DGST...-Y12		Shock absorbers at both ends, self-adjusting, with end-position adjustment (available from strokes of 30 mm)							
Max. cushioning length									
DGST...-E1 ²⁾	[mm]	0.25/0.9	0.5/1.5	0.6/1.6	0.5/1.1	0.6/0.8	0.5/1	0.5/1.2	
DGST...-P	[mm]	0.9	1.8	1.8	2	1.8	2	2	
DGST...-Y12	[mm]	4	4	4	5	5	8	10	
Position sensing		Via proximity sensor							
Mounting position		Any							
Max. speed									
DGST...-E1	[m/s]	0.5							
DGST...-P	[m/s]	0.5	0.8						
DGST...-Y12	[m/s]	0.5	0.8						
Repetition accuracy									
DGST...-E1	[mm]	≤ 0.3							
DGST...-P	[mm]	≤ 0.3							
DGST...-Y12	[mm]	≤ 0.02							

1) For variant DGST...-E1, the actual stroke is slightly longer → page 18

2) Advanced end position/retracted end position

Operating and environmental conditions		6	8	10	12	16	20	25
Size		6	8	10	12	16	20	25
Operating medium		Compressed air to ISO 8573-1:2010 [7:4:4]						
Information on the operating medium		Lubricated operation possible (in which case lubricated operation will always be required)						
Operating pressure ¹⁾	[MPa]	0.15 ... 0.8		0.1 ... 0.8				
	[bar]	1.5 ... 8		1 ... 8				
Ambient temperature	[°C]	-10 ... +60						
Corrosion resistance class CRC ²⁾		1						

1) For sizes 6/8/10/12, the min. operating pressure can increase slightly after a rest period > 24 h.

2) Corrosion resistance class CRC 1 to Festo standard FN 940070

Low corrosion stress. Dry indoor application or transport and storage protection. Also applies to parts behind coverings, in the non-visible interior area, and parts which are covered in the application (e.g. drive trunnions).

Data sheet

Forces and impact energy								
Size		6	8	10	12	16	20	25
Theoretical force at 6 bar, advancing	[N]	34	60	94	136	241	377	589
Theoretical force at 6 bar, retracting	[N]	25	45	79	102	207	317	495
Impact energy in the end positions								
DGST...-E1	[Nm]	0.005	0.03	0.05	0.07	0.15	0.2	0.3
DGST...-P	[Nm]	0.018	0.05	0.08	0.12	0.25	0.35	0.45
DGST...-Y12, per stroke	[Nm]	0.1	0.4	0.8	1.4	2	3	6
Max. operating frequency								
DGST...-Y12	[Cycles/min]	50	80	80	80	70	50	50

For cushioning DGST...-E1/-P, the following applies:

Permissible impact velocity:

$$v = \sqrt{\frac{2 \cdot E}{m_1 + m_2}}$$

Maximum permissible mass:

$$m_2 = \frac{2 \cdot E}{v^2} - m_1$$

- v Permissible impact velocity
- E Maximum impact energy
- m₁ Moving mass (drive)
- m₂ Moving payload

 **Note**
 These specifications represent the maximum values that can be achieved. Observe the maximum permissible impact energy.

For cushioning DGST...-Y12, the following applies:

Permissible impact velocity:

$$v = \sqrt{\frac{2 \cdot (E - (F + (m_1 + m_2) \cdot g \cdot \sin(\alpha)) \cdot s)}{m_1 + m_2}}$$

Maximum permissible mass:

$$m_2 = \frac{E - F \cdot s}{\frac{1}{2} \cdot v^2 + g \cdot s \cdot \sin(\alpha)} - m_1$$

- v Permissible impact velocity
- E Kinetic impact energy
- F Cylinder force minus friction force
- m₁ Moving mass (drive)
- m₂ Moving payload
- g Gravitational acceleration
- s Shock absorber stroke
- a Impact angle
- v Impact velocity

 **Note**
 These specifications represent the maximum values that can be achieved. Observe the maximum permissible impact energy.

Data sheet

Weight [g] Size	Stroke [mm]	6	8	10	12	16	20	25
Product weight without cushioning component								
	10	90	129	247	391	454	978	1463
	20	107	154	254	456	526	970	1528
	30	124	176	292	501	510	994	1547
	40	140	200	324	563	629	1055	1743
	50	172	236	359	611	690	1196	1816
	80	–	310	496	776	930	1618	2452
	100	–	–	561	988	1060	1962	2868
	125	–	–	–	–	1294	2346	3507
	150	–	–	–	–	1402	2686	3927
	200	–	–	–	–	–	3275	4803
Moving mass without cushioning component								
	10	49	69	124	195	235	440	714
	20	57	80	134	238	278	456	762
	30	65	92	146	242	277	455	762
	40	73	103	165	284	324	498	877
	50	88	122	177	290	342	549	897
	80	–	155	240	360	462	759	1217
	100	–	–	269	465	515	890	1388
	125	–	–	–	–	637	1068	1703
	150	–	–	–	–	660	1221	1877
	200	–	–	–	–	–	1460	2282
Cushioning components (1 cushioning element and 1 threaded sleeve)¹⁾								
DGST...-P		5	8.4	11.7	23	41	72.5	136.5
DGST...-Y12		3.9	7.8	10.2	16	33	57	105

1) Add 1x for moving mass and 2x for total mass.

Materials

Sectional view

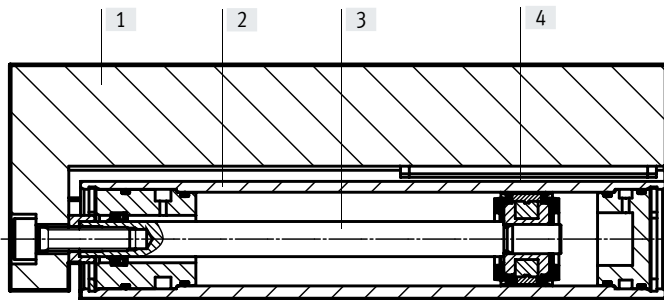

Mini slide

[1] Slide	Anodised wrought aluminium alloy
[2] Housing	Anodised wrought aluminium alloy
[3] Piston rod	High-alloy stainless steel
[4] Guide	High-alloy stainless steel, POM, TPE
– Seals	HNBR
Note on materials	Free of copper and PTFE RoHS-compliant
DGST...-F1A	Metals with copper, zinc or nickel as the main constituent are excluded from use. Exceptions are nickel in steels, chemically nickel-plated surfaces, printed circuit boards, cables, electrical plug connectors and coils.

Data sheet

Perpendicularity

The term perpendicularity refers to the alignment accuracy between the slide surface and the yoke plate.

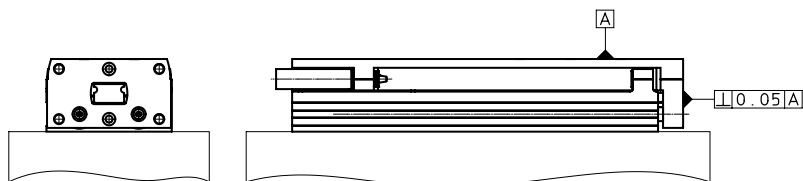

Size	6	8	10	12	16	20	25
	≤ 0.05						

Parallelism

The term parallelism refers to the alignment accuracy between the mounting surface and the slide surface in longitudinal direction.

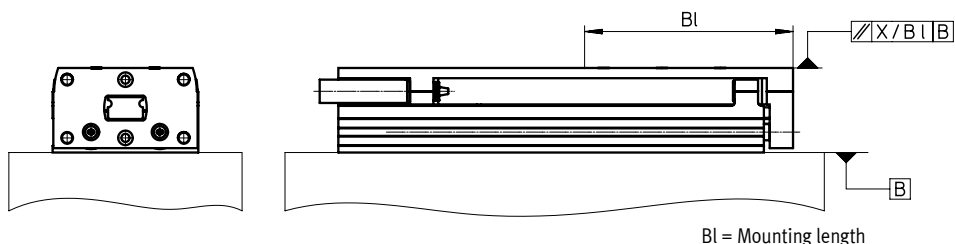

Size Stroke [mm]	6	8	10	12	16	20	25
10	0.09 2/43 ¹⁾	0.09/45	0.09 3/54	0.08 6/55	0.08 9/61	0.08 1/80	0.08 8/90
20	0.08 2/43	0.08 1/45	0.09/54	0.08 5/55	0.08 5/61	0.08 1/80	0.08 8/90
30	0.07 9/43	0.07 8/45	0.08 4/54	0.07 6/55	0.08 1/61	0.08 1/80	0.08 2/90
40	0.11 4/65	0.11 8/70	0.08 5/54	0.07 5/55	0.08 3/61	0.07 5/80	0.07 6/90
50	0.09 6/65	0.10 3/70	0.11 3/76	0.10 1/77	0.10 9/85	0.06 5/80	0.07 7/90
80	-	0.09 5/70	0.09 1/76	0.09 5/77	0.08 4/85	0.07 4/130	0.07 4/130
100	-	-	0.09 1/76	0.07 2/77	0.09 8/101	0.06 2/130	0.06 1/130
125	-	-	-	-	0.08 1/101	0.06 3/160	0.06 3/160
150	-	-	-	-	0.07 9/101	0.05 5/160	0.05 5/160
200	-	-	-	-	-	0.04 4/160	0.04 4/160

1) Parallelism/mounting length

Linearity

The term linearity refers to the alignment accuracy between the mounting surface and the slide surface in relation to the stroke.

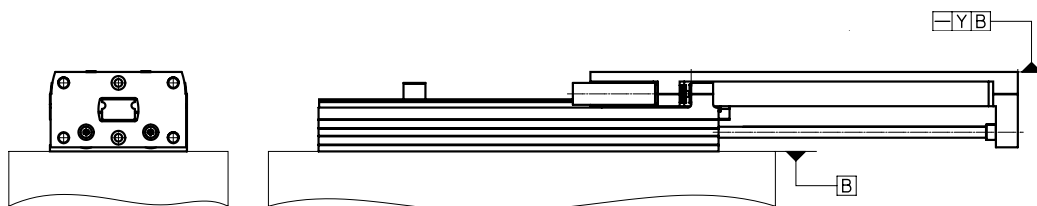

Size Stroke [mm]	6	8	10	12	16	20	25
10	0.013	0.012	0.011	0.011	0.01	0.009	0.009
20	0.021	0.02	0.018	0.016	0.016	0.014	0.014
30	0.025	0.024	0.023	0.021	0.021	0.02	0.018
40	0.029	0.028	0.026	0.025	0.025	0.022	0.021
50	0.031	0.029	0.029	0.027	0.026	0.024	0.023
80	-	0.034	0.032	0.032	0.03	0.02	0.027
100	-	-	0.035	0.032	0.032	0.027	0.027
125	-	-	-	-	0.033	0.028	0.028
150	-	-	-	-	0.035	0.03	0.03
200	-	-	-	-	-	0.032	0.032

The values apply in an unpressurised state. When variants DGST...-P and DGST...-Y12 are supplied with compressed air, this may result in a tilting motion.

Data sheet

Adjustable end-position range

Precision adjustment of the advanced and retracted end position

Precision adjustment of the required stroke reduction is possible using the cushioning components.

Advantages:

- No readjustment required; position is fully maintained under lock and load
- Stroke reduction down to the next size down of standard stroke is possible
- Fast and simple adjustment using two tools

Step 1:

Screw the cushioning component and sleeve into the holder using a hex wrench until the stop is reached

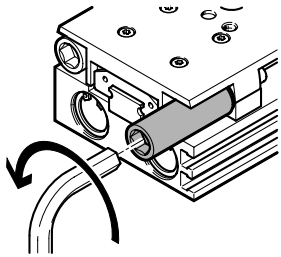
**Step 2:**

Set the exact end position using a smaller hex wrench

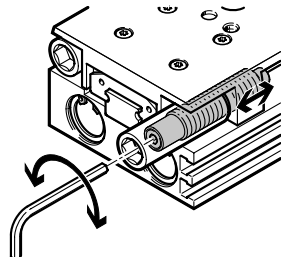
**Step 3:**

Secure the cushioning component by tightening the sleeve

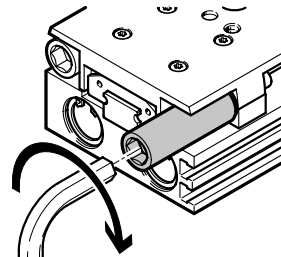
**End-position adjustment**

Dimensions:

For DGST-...-P: → page 38

For DGST-...-Y12: → page 40

**Note**

Adjust and secure the shock absorber under compressed air.

Data sheet

Dynamic characteristic load values

The indicated torques refer to the centre of the guide.
 These values must not be exceeded during dynamic operation. Special attention must be paid to the cushioning phase.

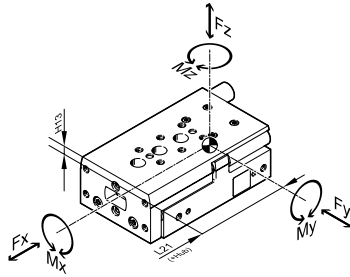

If the drive is simultaneously subjected to several of the forces and torques indicated below, the following equation must be satisfied in addition to the indicated maximum loads:

$$f_v = \frac{|F_{y1}|}{F_{y2}} + \frac{|F_{z1}|}{F_{z2}} + \frac{|M_{x1}|}{M_{x2}} + \frac{|M_{y1}|}{M_{y2}} + \frac{|M_{z1}|}{M_{z2}} \leq 1$$

f_v = load comparison factor
 F_1 = dynamic value
 F_2 = maximum value

Position of the guide centre

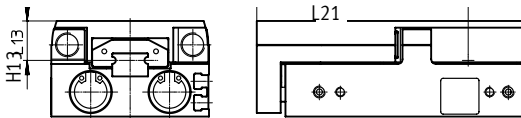

Calculation example

Given:

To be calculated:

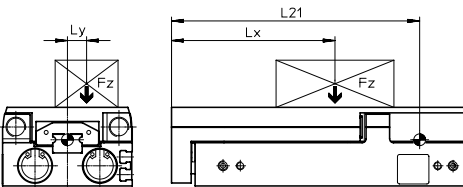

Mini slide	= DGST-10	F_y, F_z, M_x, M_y, M_z
Stroke length	= 0.08 m	and
Lever arm L_x	= 0.05 m	Proof of functionality with combined
Lever arm L_y	= 0.03 m	load
Mass F_z	= 0.8 kg	
Acceleration a	= 0 m/s ²	

Solution:

$L_{21} = 0.1102$ m from table

$F_y = 0$ N

$F_z = m \times g$
 $= 0.8 \text{ kg} \times 9.81 \text{ m/s}^2 = 7.848$ N

$M_x = m \times g \times L_y$
 $= 0.8 \text{ kg} \times 9.81 \text{ m/s}^2 \times 0.03 \text{ m} = 0.236$ Nm

$M_y = m \times g \times [(L_{21} + \text{Hub}) - L_x]$
 $= 0.8 \text{ kg} \times 9.81 \text{ m/s}^2 \times [(0.1102 \text{ m} + 0.08 \text{ m}) - 0.05 \text{ m}] = 1.1$ Nm

$M_z = 0$ Nm

Combined load:

$$f_v = \frac{|F_{y1}|}{F_{y2}} + \frac{|F_{z1}|}{F_{z2}} + \frac{|M_{x1}|}{M_{x2}} + \frac{|M_{y1}|}{M_{y2}} + \frac{|M_{z1}|}{M_{z2}} \leq 1$$

$$= 0 + \frac{7,848 \text{ N}}{520 \text{ N}} + \frac{0,236 \text{ Nm}}{6 \text{ Nm}} + \frac{1,1 \text{ Nm}}{5 \text{ Nm}} + 0 = 0,274 \leq 1$$

Permissible forces and torques

Geometric characteristics

Size	Stroke [mm]	$F_{y_{max}}, F_{z_{max}}$ [N]	$M_{x_{max}}$ [Nm]	$M_{y_{max}}, M_{z_{max}}$ [Nm]	H13 [mm]	L21 [mm]
6	10	200	1.1	0.7	9.35	31
	20	220	1.1	1		39.5
	30	240	1.1	1.2		51
	40	260	1.2	1.2		59.5
	50	280	1.4	1.2		73.5
8	10	250	2	2	10.75	31
	20	275	2	2		39.5
	30	300	2.8	2		51
	40	325	3	2.5		59.5
	50	350	3.2	3		73.5
	80	375	3.2	3		103.5

Data sheet

Permissible forces and torques					Geometric characteristics	
Size	Stroke [mm]	$F_{y_{max}}, F_{z_{max}}$ [N]	$M_{x_{max}}$ [Nm]	$M_{y_{max}}, M_{z_{max}}$ [Nm]	H13 [mm]	L21 [mm]
10						
	10	470	3	3	12.25	45.7
	20	480	3	3		45.7
	30	490	3.5	3		58.5
	40	500	4	4.5		65.7
	50	510	5	4.5		78.5
	80	520	6	5		110.2
	100	530	6	6		130.2
12						
	10	500	4.2	4.2	14.5	43
	20	520	4.2	4.2		53
	30	540	4.2	4.2		63
	40	560	5.8	5.8		73
	50	580	7	5.8		83
	80	600	8.9	6.5		113
	100	620	10	6.8		139
16						
	10	820	11.3	7	16.5	48.5
	20	840	11.3	7		55.5
	30	860	11.3	7.5		59.5
	40	880	11.3	8		71.5
	50	900	11.3	8		88.5
	80	920	12	10		119
	100	940	12	10		139
	125	960	14	15		171.5
	150	960	14	16		196.5
20						
	10	1600	16	18	16	70
	20	1270	13	14		70
	30	1110	11	12		71
	40	930	10	11		82
	50	1080	9	10		93.6
	80	1030	14	11		131.4
	100	1160	18	11		160.3
	125	1380	20	17		192.6
	150	1300	20	17		222.8
	200	1170	20	17		279.6
25						
	10	1840	19	21	21	69.2
	20	1460	16	16		69.2
	30	1280	14	14		78.2
	40	1310	13	12		88.2
	50	1080	12	11		98.2
	80	1030	14	11		133.4
	100	1160	18	11		162.8
	125	1380	20	17		194.6
	150	1300	20	17		224.8
	200	1170	20	17		281.6

Data sheet

Payload m as a function of impact velocity v and cushioning $P/E1$

DGST-6

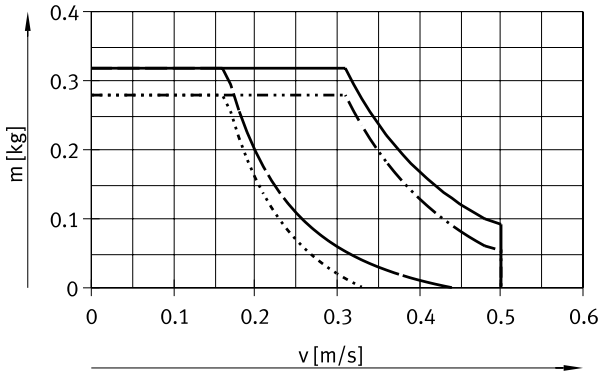

- DGST-6-10-P
- DGST-6-50-P
- - - DGST-6-10-E1
- · - · DGST-6-50-E1

DGST-8

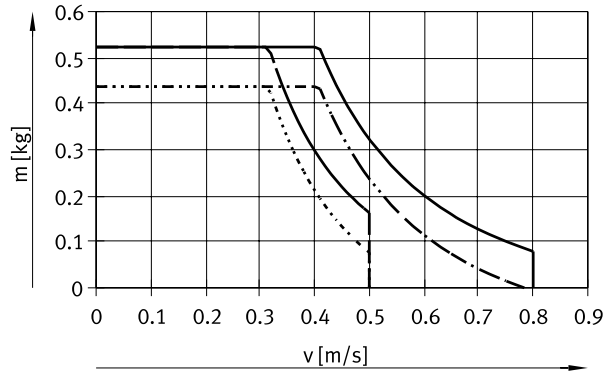

- DGST-8-10-P
- DGST-8-80-P
- - - DGST-8-10-E1
- · - · DGST-8-80-E1

DGST-10

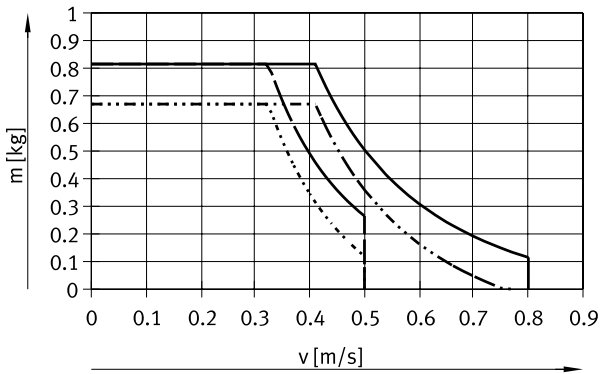

- DGST-10-10-P
- DGST-10-100-P
- - - DGST-10-10-E1
- · - · DGST-10-100-E1

DGST-12

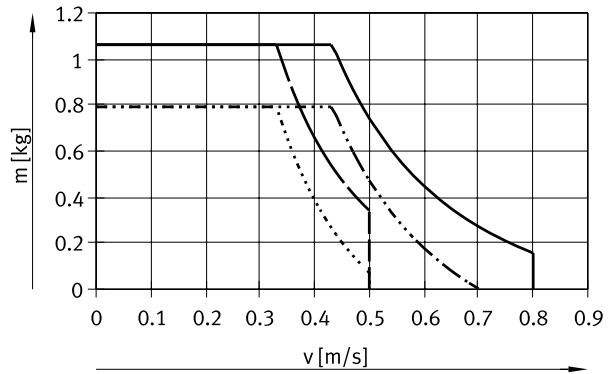

- DGST-12-10-P
- DGST-12-100-P
- - - DGST-12-10-E1
- · - · DGST-12-100-E1

Data sheet

Payload m as a function of impact velocity v and cushioning $P/E1$

DGST-16

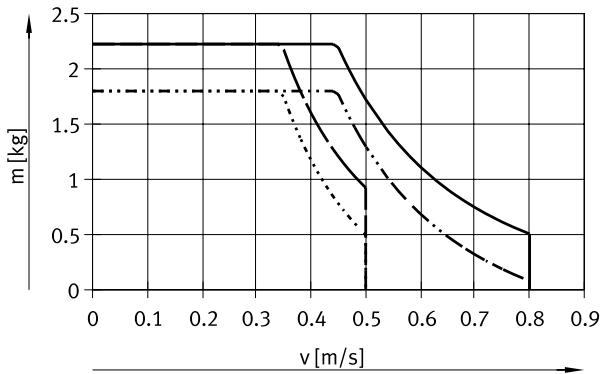

- DGST-16-10-P
- · - · - DGST-16-150-P
- - - DGST-16-10-E1
- · · · · DGST-16-150-E1

DGST-20

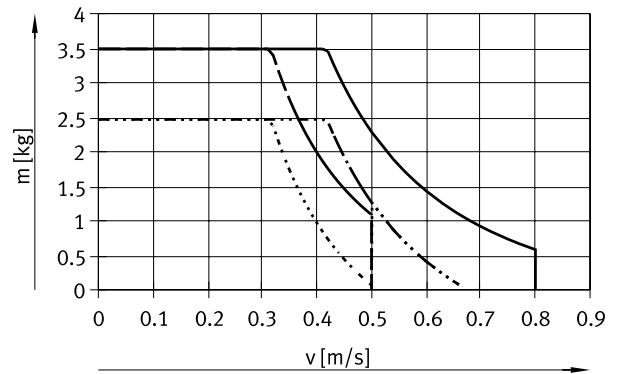

- DGST-20-10-P
- · - · - DGST-20-200-P
- - - DGST-20-10-E1
- · · · · DGST-20-200-E1

DGST-25

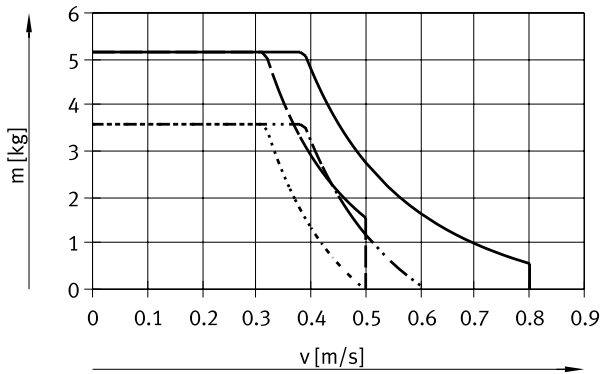

- DGST-25-10-P
- · - · - DGST-25-200-P
- - - DGST-25-10-E1
- · · · · DGST-25-200-E1

Data sheet

Payload m as a function of impact velocity v and cushioning Y12

DGST-6

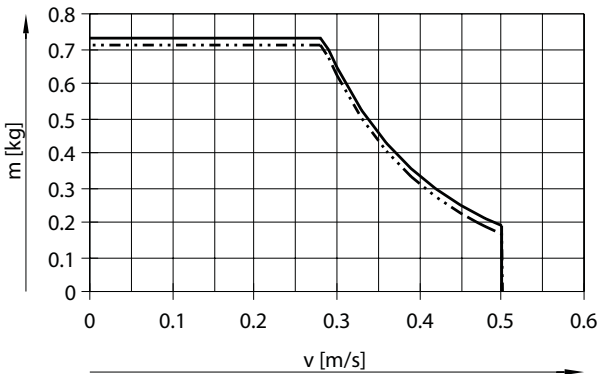

- DGST-6-30-Y12
- - - DGST-6-50-Y12

DGST-8

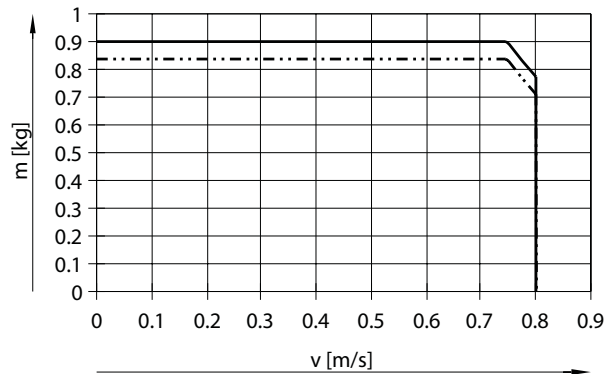

- DGST-8-30-Y12
- - - DGST-8-80-Y12

DGST-10

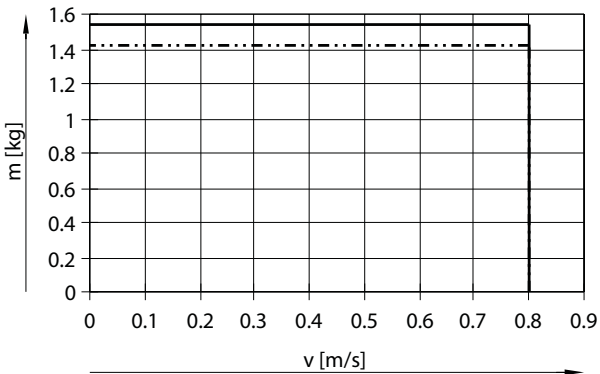

- DGST-10-30-Y12
- - - DGST-10-100-Y12

DGST-12

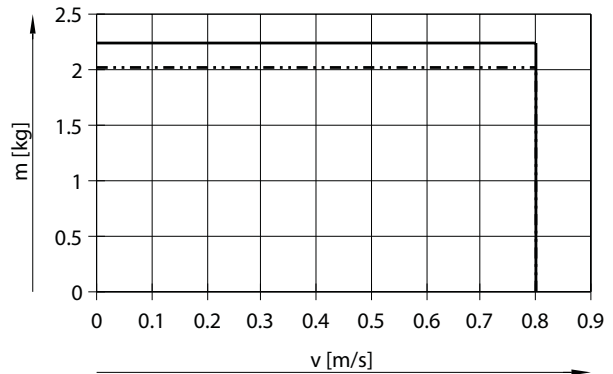

- DGST-12-30-Y12
- - - DGST-12-100-Y12

Data sheet

Payload m as a function of impact velocity v and cushioning Y12

DGST-16

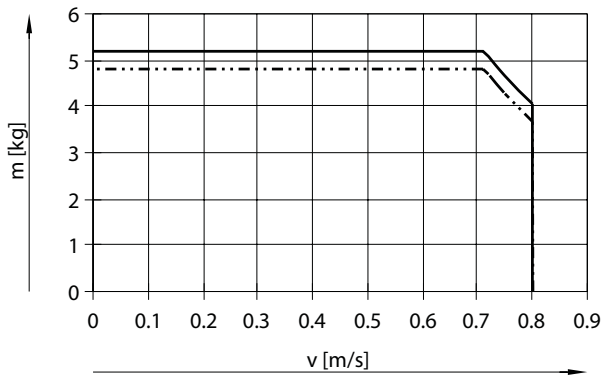

- DGST-16-30-Y12
- · - · - DGST-16-150-Y12

DGST-20

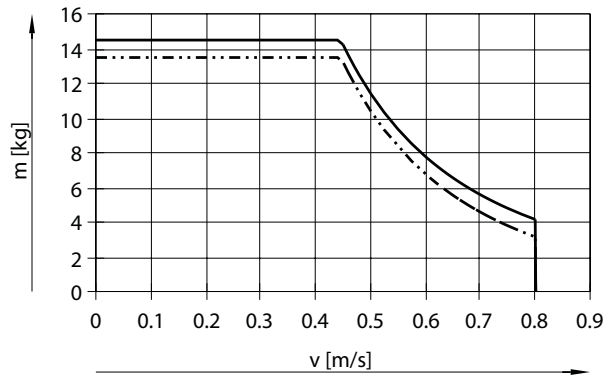

- DGST-20-30-Y12
- · - · - DGST-20-200-Y12

DGST-25

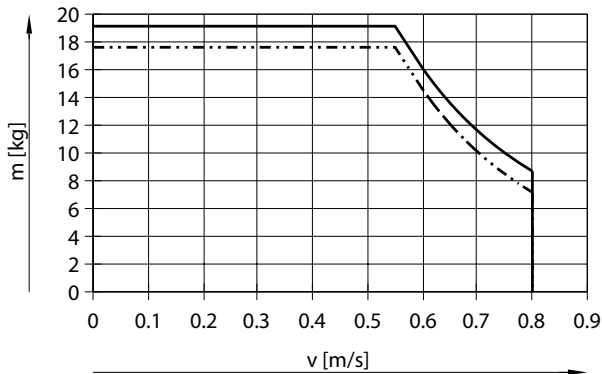

- DGST-25-30-Y12
- · - · - DGST-25-200-Y12

Data sheet

Dimensions

Download CAD data → www.festo.com

[] Standard

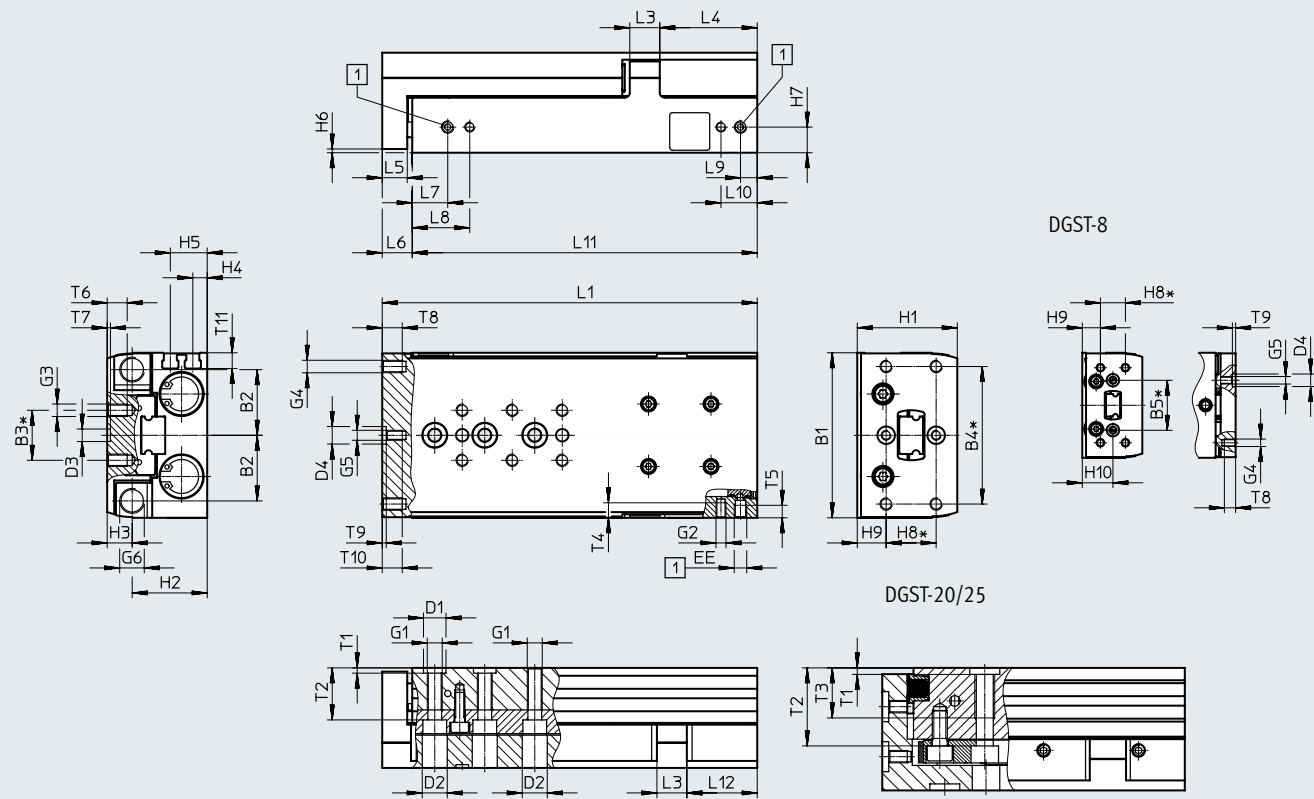

Actual stroke with variant DGST...-E1 =
stroke + additional stroke without cushioning + cushioning
stroke (values → page 19)

- [1] = supply ports
- * = ±0.02 mm applies to the centring
- = = ±0.1 mm applies to the thread

Size	B1	B2	B3	B4	B5	D1	D2	D3	D4	EE	G1	G2	G3	G4
			±0.1	±0.1		∅ H7	∅	∅ H7	∅					
6	35	14.4	10	30	–	5	6	5	2 ^{H8}	M3	M4	M3	M3	M3
8	42	17	10	30	20	5	6	5	5 ^{H7}	M5	M4	M3	M3	M3
10	50	20.8	20	40	–	7	8	5	5 ^{H7}	M5	M5	M4	M4	M4
12	60	24.5	20	40	–	7	8	5	7 ^{H7}	M5	M5	M4	M4	M4
16	66	26.3	20	55	–	9	10	5	7 ^{H7}	M5	M6	M4	M5	M5
20	85	34.5	40	70	–	12	11	12	12 ^{H7}	G1/8	M8	M5	M5	M5
25	104	42	40	80	–	12	11	12	12 ^{H7}	G1/8	M8	M6	M6	M6

Size	G5	G6	H1	H2	H3	H4	H5	H6	H7	H8	H9	H10	L3	L4
6	–	M4x0.5	20	14.5	5.5	2.5	7	1.5	4.5	10	5	–	5	22
8	M3	M5x0.5	24	17.7	6.3	3.1	8.1	1.5	5.6	10	7.3	12.3	6	30.5
10	M3	M6x0.5	29	21	8	4	10	1.5	7	20	5	–	8	31
12	M4	M8x1	36	26.5	9.5	5.9	11.9	1.5	8.9	20	9.5	–	10	36
16	M4	M10x1	40	30	10	5.8	14.8	1.5	10.3	20	11.6	–	12	39
20	M5	M12x1	49	36.5	12.5	8.7	17.7	2.5	13.2	20	15.5	–	14.5	51
25	M6	M14x1	60	44.5	15.5	11	21	2.5	16	40	10	–	17.5	65

Data sheet

Size	L5	L6 ¹⁾	L7	L8 ²⁾	L9	L10 ²⁾	T1	T2	T3 ³⁾ max.	T4 ³⁾ max.	T5 ³⁾ max.
6	6	8	8.5	15.4	5.8	12.7	1.3 ^{+0.1}	8.9	–	4	4
8	6	8	8.5	16.5	5.5	13.5	1.3 ^{+0.1}	11.5	–	5	4.5
10	8	10	8.9	17.9	6.6	15.6	1.6 ^{+0.1}	14.5	–	6.2	5
12	8	10	10.7	19.5	7	15.8	1.6 ^{+0.1}	19.8	–	7	5.5
16	10	12	14.2	23	6.7	15.5	2.1 ^{+0.1}	20.8	–	6	5
20	10	12.5	16.5	30.5	8	22	2.6 ^{+0.3}	31.2	20	8	8.5
25	12	14.5	16.5	31.5	10.5	25.5	2.6 ^{+0.3}	37.2	20	9.5	8

Size	T7	T8 ³⁾ max.	T9	T10 ³⁾ max.	T11	Additional stroke without cushioning with variant DGST...-E1		Max. cushioning stroke in the end positions with variant DGST...-E1	
						min.	max.	Front	Rear
6	1.3 ^{+0.1}	4.5	–	–	4.6	0.65	1.3	0.25	0.9
8	1.3 ^{+0.1}	4.5	1.3 ^{+0.1}	–	5	0	0.7	0.5	1.6
10	1.3 ^{+0.1}	6.5	1.3 ^{+0.1}	6.5	5.9	0	0.7	0.6	1.6
12	1.3 ^{+0.1}	6.5	1.6 ^{+0.1}	8	7	0.4	1.1	0.5	1.1
16	1.3 ^{+0.1}	8	1.6 ^{+0.1}	8	6.3	0.65	1.4	0.6	0.65
20	2.6 ^{+0.3}	8	2.6 ^{+0.3}	10	9.1	0.4	1.1	0.5	1
25	2.6 ^{+0.3}	10	2.6 ^{+0.3}	13	8.8	0.5	1.2	0.5	1.2

Stroke [mm] Size	10	20	30	40	50	80	100	125	150	200
L1¹⁾										
6	48	58	68	78	95	–	–	–	–	–
8	51	61	71	81	95	126	–	–	–	–
10	66	68	78	88	98	136	156	–	–	–
12	66	76	86	96	106	136	169.5	–	–	–
16	73	80	87	97	112	150	170	210	235	–
20	97	97	97	107	121	166	204.5	244	279	343
25	102	102	108	118	128	168	207	246	281	345
L11										
6	40	50	60	70	87	–	–	–	–	–
8	43	53	63	73	87	118	–	–	–	–
10	56	58	68	78	88	126	146	–	–	–
12	56	66	76	86	96	126	159.5	–	–	–
16	61	68	75	85	100	138	158	198	223	–
20	84.5	84.5	84.5	94.5	108.5	153.5	192	231.5	266.5	330.5
25	87.5	87.5	93.5	103.5	113.5	153.5	192.5	231.5	266.5	330.5
L12										
6	16	16	16	16	22	–	–	–	–	–
8	15.7	15.7	15.7	15.7	19.7	20.7	–	–	–	–
10	24.6	16.6	16.6	16.6	16.6	24.6	24.6	–	–	–
12	20.6	20.6	20.6	20.6	20.6	20.6	34.1	–	–	–
16	21.2	18.2	15.2	15.2	20.2	28.2	28.2	39	39	–
20	39.5	29.5	19.5	19.5	23.5	38.5	51	51	51	51
25	36.5	26.5	22.5	22.5	22.5	32.5	51.5	65	65	65
T6 (max.)³⁾										
6	4	4	4	4	4	–	–	–	–	–
8	5.5	5.5	5.5	5.5	5.5	5.5	–	–	–	–
10	4.5	4.5	4.5	4.5	4.5	7.5	7.5	–	–	–
12	5.2	5.2	5.2	5.2	5.2	8	8	–	–	–
16	7.2	7.2	7.2	7.2	7.2	8	8	8	8	–
20	8	8	8	8	8	8	8	8	8	8
25	11	11	11	11	11	11	11	11	11	11

1) At an operating pressure of 6 bar for the "E1" version. For the other damping variants LD1 → page 38

2) Not available in sizes 6 and 8 with stroke 10 mm. For size 16 with stroke of 80 ... 150 mm, the measurement is 14.5 mm

3) Max. screw-in depth

Data sheet

Dimensions

Download CAD data → www.festo.com

[L] Mirror-inverted

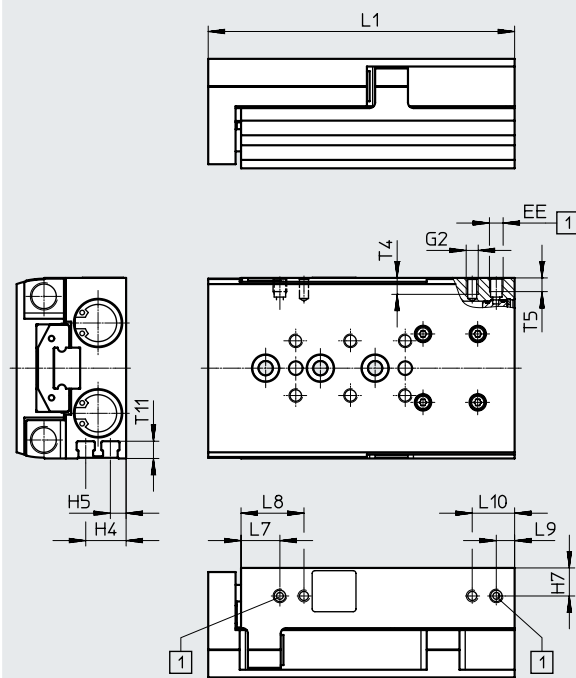

+ = plus stroke length

[1] Supply ports

- Note

In the mirror-inverted version, the supply ports and sensor slots are located on the opposite side when compared with the standard version. This enables the space-saving mounting of mini-slides next to one another.

All further dimensions correspond to the standard version → page 18

Data sheet

Size	EE	G2	H4	H5	H7	L7	L8 ²⁾	L9	L10 ²⁾	T4 ³⁾ max.	T5 ³⁾ max.	T11
6	M3	M3	2.5	7	4.5	8.5	15.4	5.8	12.7	4	4	4.6
8	M5	M3	3.1	8.1	5.6	8.5	16.5	5.5	13.5	5	4.5	5
10	M5	M4	4	10	7	8.9	17.9	6.6	15.6	6.2	5	5.9
12	M5	M4	5.9	11.9	8.9	10.7	19.5	7	15.8	7	5.5	7
16	M5	M4	5.8	14.8	10.3	14.2	23	6.7	15.5	6	5	6.3
20	G1/8	M5	8.7	17.7	13.2	16.5	30.5	8	22	8	8.5	9.1
25	G1/8	M6	11	21	16	16.5	31.5	10.5	25.5	9.5	8	8.8

Stroke [mm]	10	20	30	40	50	80	100	125	150	200	
Size											
	L1¹⁾										
6	48	58	68	78	95	–	–	–	–	–	
8	51	61	71	81	95	126	–	–	–	–	
10	66	68	78	88	98	136	156	–	–	–	
12	66	76	86	96	106	136	169.5	–	–	–	
16	73	80	87	97	112	150	170	210	235	–	
20	97	97	97	107	121	166	204.5	244	279	343	
25	102	102	108	118	128	168	207	246	281	345	

1) At an operating pressure of 6 bar

2) Not available in sizes 6 and 8 with stroke 10 mm. For size 16 with stroke of 80 ... 150 mm, the measurement is 14.5 mm

3) Max. screw-in depth

Data sheet

Hole pattern for mounting threads and centring holes

Download CAD data → www.festo.com

DGST-6-10

DGST-6-20

DGST-6-30

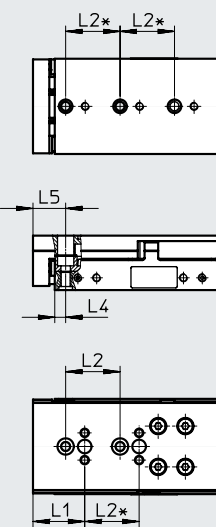
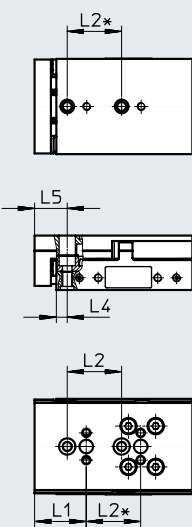
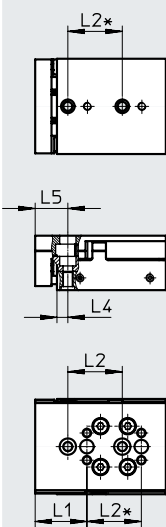

DGST-6-40

DGST-6-50

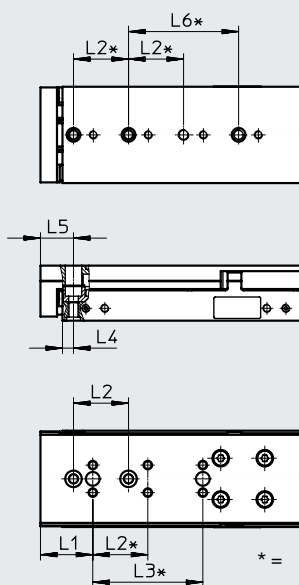
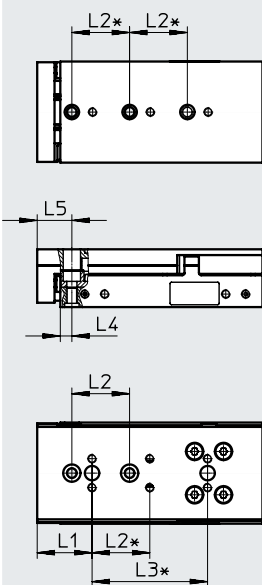

* = ±0.02 mm applies to the centring
 = ±0.1 mm applies to the thread

Size	Stroke [mm]	L1	L2	L3	L4	L5	L6
6	10	19	20	-	4	12	-
	20			-			-
	30			-			-
	40			40			-
	50			40			40

Data sheet

Hole pattern for mounting threads and centring holes

Download CAD data → www.festo.com

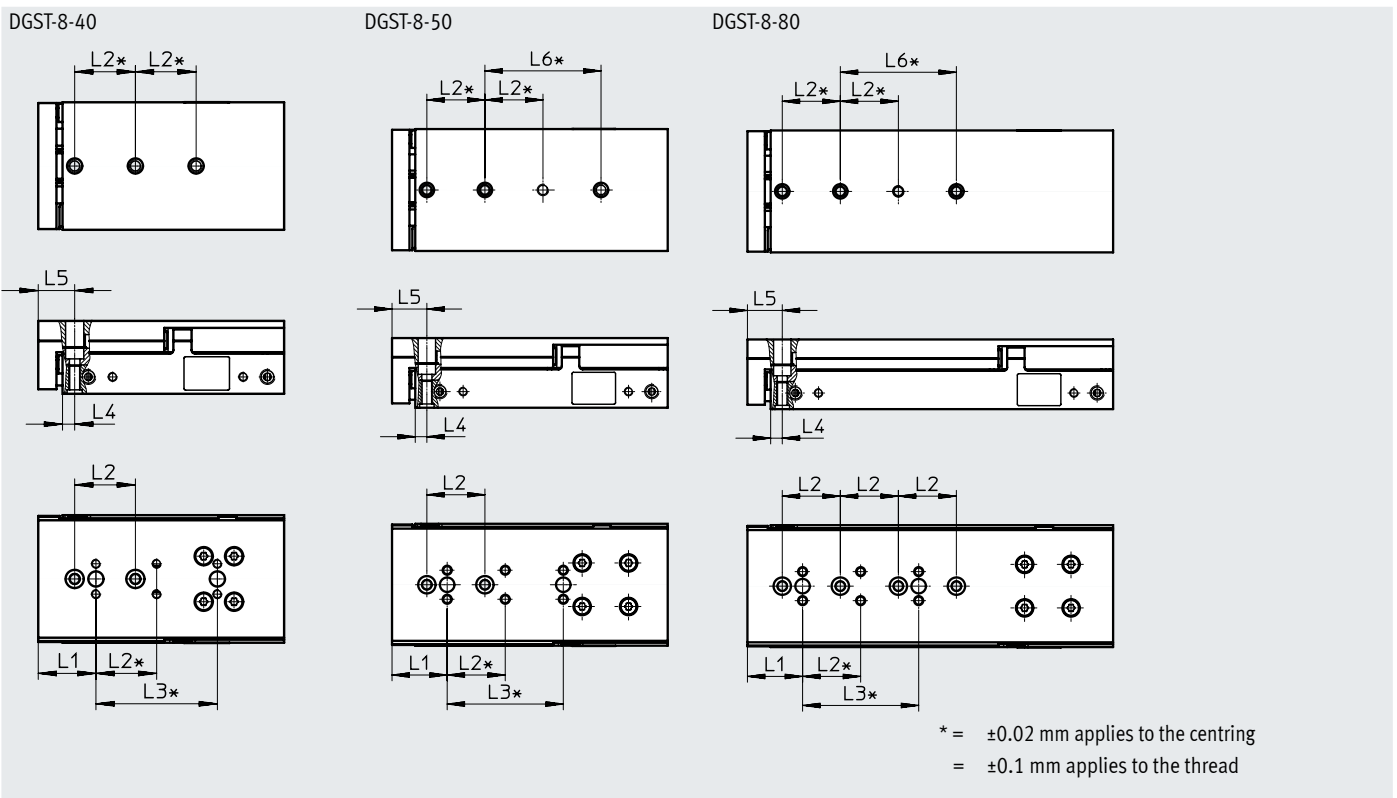
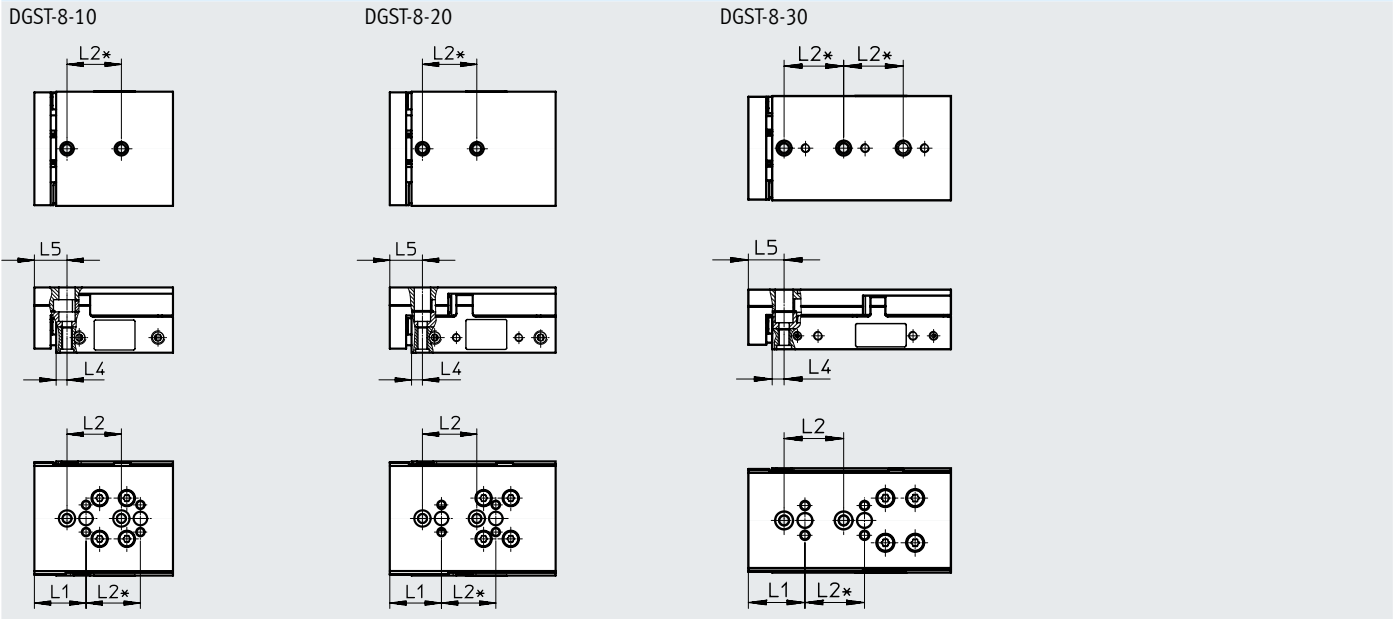

* = ±0.02 mm applies to the centring
 = ±0.1 mm applies to the thread

Size	Stroke [mm]	L1	L2	L3	L4	L5	L6
8	10	19	20	-	4	12	-
	20			-			-
	30			-			-
	40			40			-
	50			40			40
	80			40			40

Data sheet

Hole pattern for mounting threads and centring holes

Download CAD data → www.festo.com

DGST-10-10/20

DGST-10-30

DGST-10-40/50

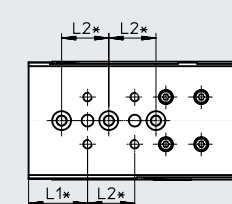
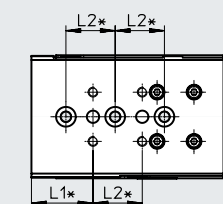
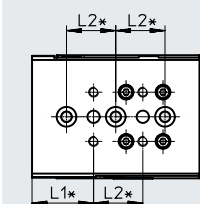
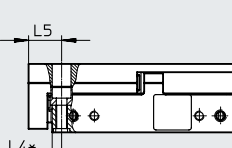
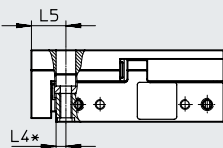
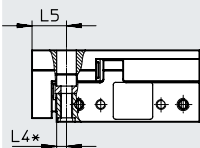
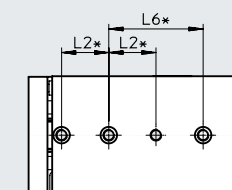
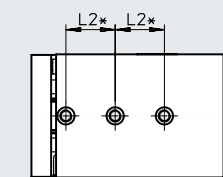
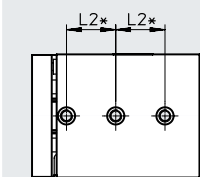

DGST-10-80

DGST-10-100

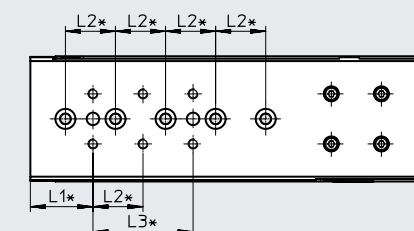
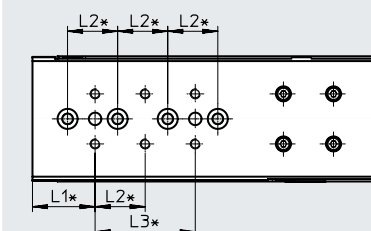
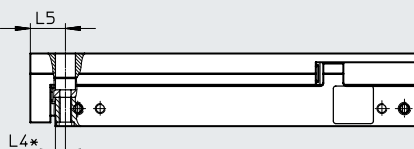
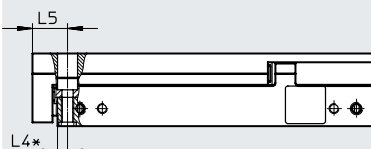
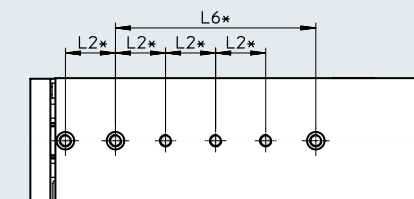
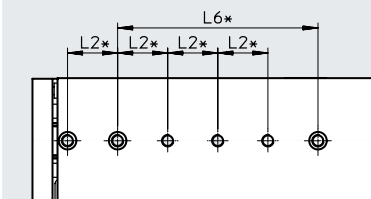

* = ±0.02 mm applies to the centring
 = ±0.1 mm applies to the thread

Size	Stroke [mm]	L1	L2	L3	L4	L5	L6
10	10, 20	25	20	-	4	14	-
	30			-			-
	40, 50			-			40
	80			40			80
	100			40			80

Data sheet

Hole pattern for mounting threads and centring holes

Download CAD data → www.festo.com

DGST-12-10

DGST-12-20

DGST-12-30

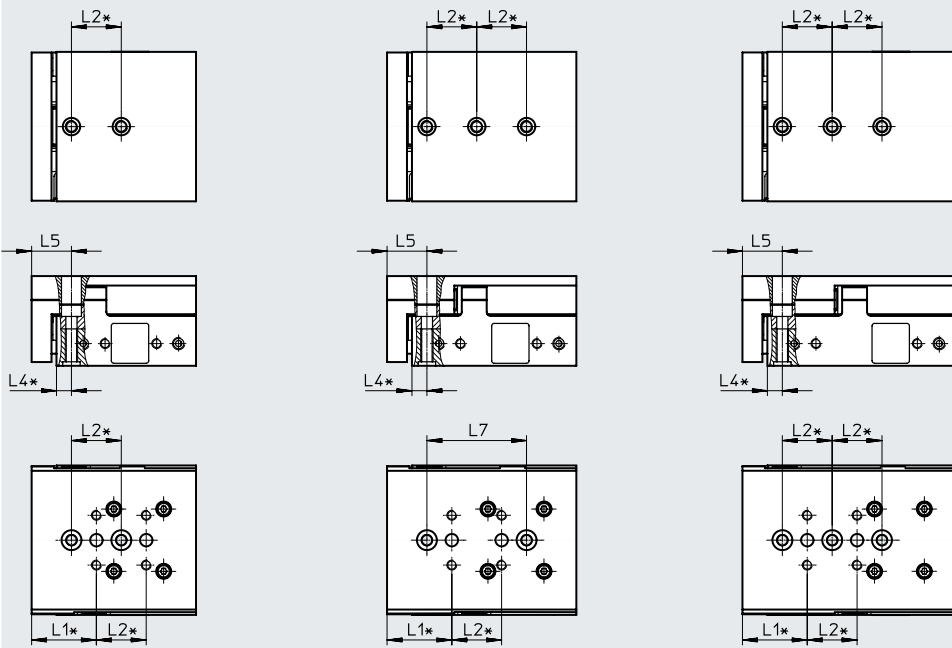

DGST-12-40

DGST-12-50/80

DGST-12-100

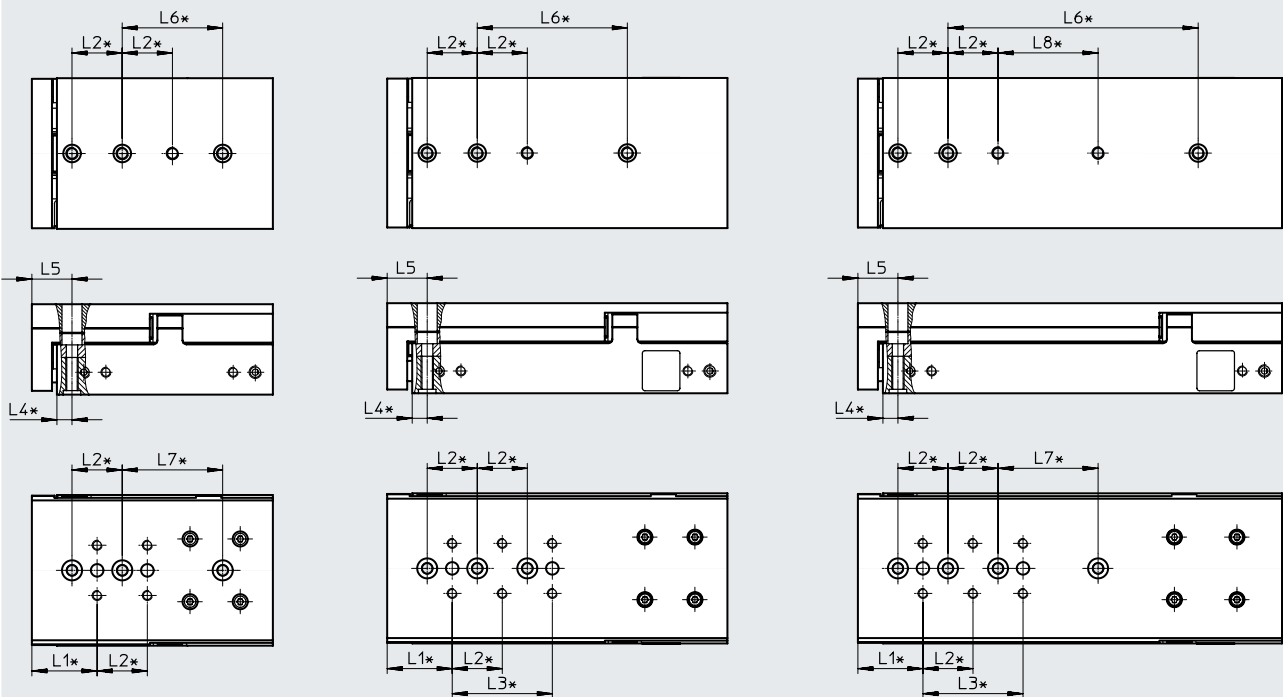

* = ±0.02 mm applies to the centring
 = ±0.1 mm applies to the thread

Size	Stroke [mm]	L1	L2	L3	L4	L5	L6	L7	L8
12	10	26	20	-	6	16	-	-	-
	20			-			40	-	
	30			-			-	-	
	40			40			40	-	
	50, 80			40			-	-	
100	40	40	40						

Data sheet

Hole pattern for mounting threads and centring holes

Download CAD data → www.festo.com

DGST-16-10

DGST-16-20/30

DGST-16-40

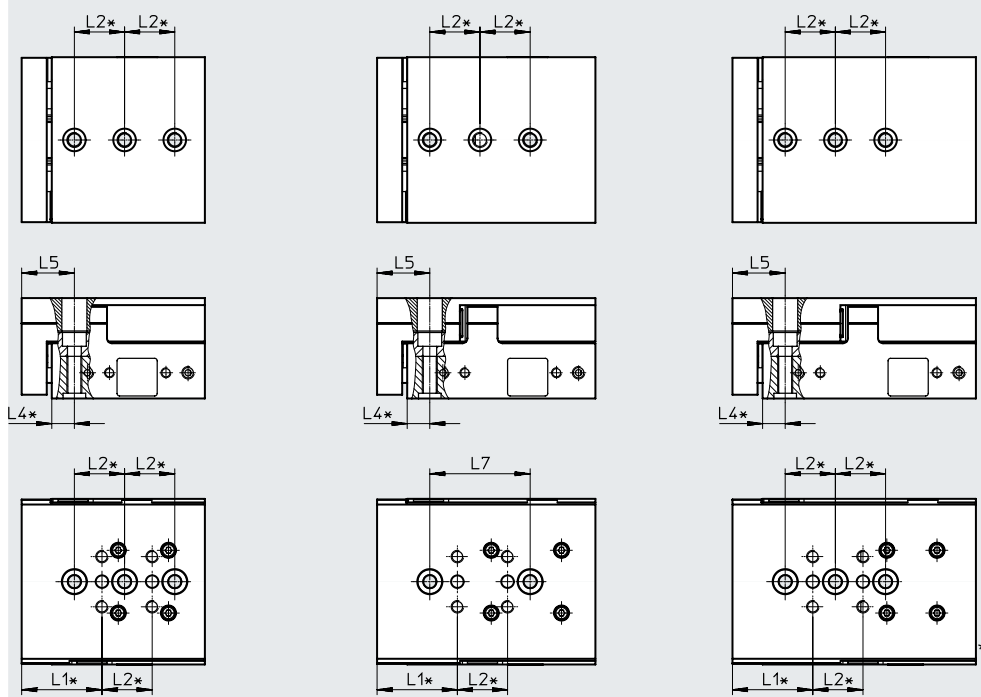

* = ±0.02 mm applies to the centring
 = ±0.1 mm applies to the thread

Size	Stroke [mm]	L1	L2	L4	L5	L7
16	10	32	20	9	21	-
	20					40
	30					40
	40					-

Data sheet

Hole pattern for mounting threads and centring holes

Download CAD data → www.festo.com

DGST-16-50

DGST-16-80

DGST-16-100

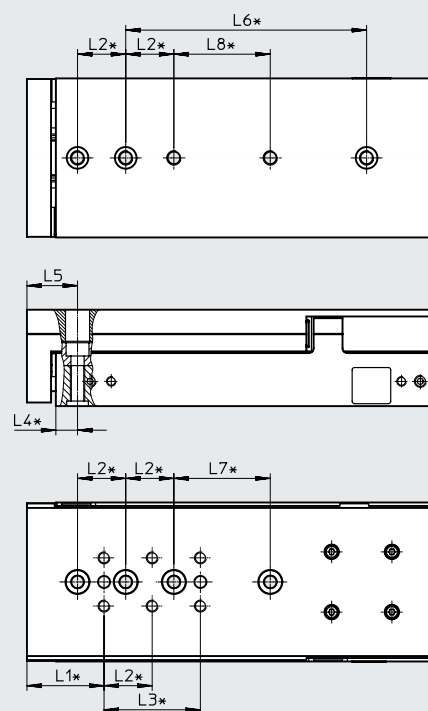
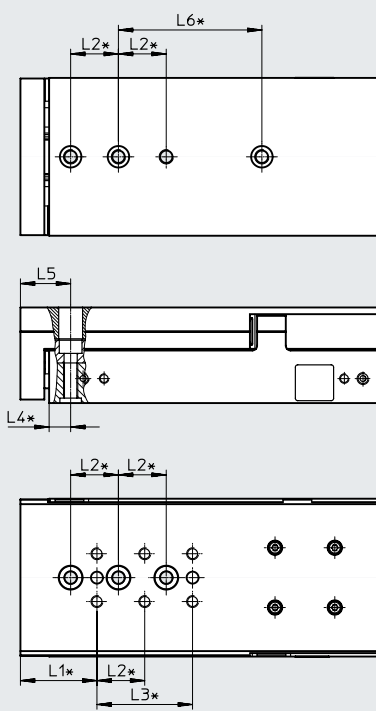
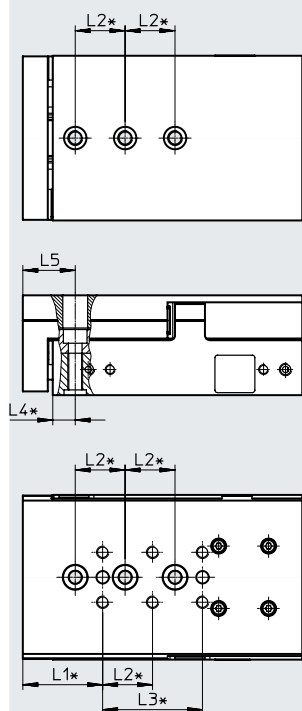

* = ± 0.02 mm applies to the centring
 = ± 0.1 mm applies to the thread

Size	Stroke [mm]	L1	L2	L3	L4	L5	L6	L7	L8
16	50	32	20	40	9	21	-	-	-
	80						60	-	-
	100						100	40	40

Data sheet

Hole pattern for mounting threads and centring holes

Download CAD data → www.festo.com

DGST-16-125

DGST-16-150

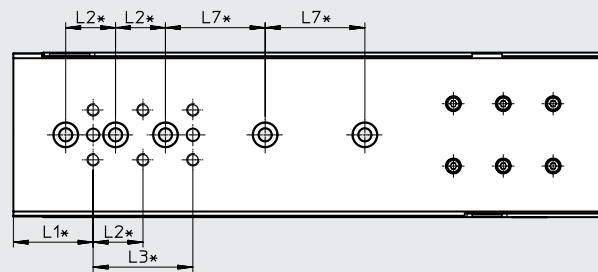
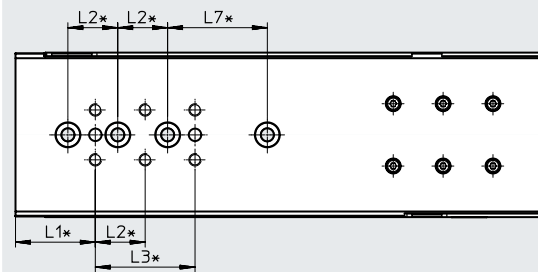
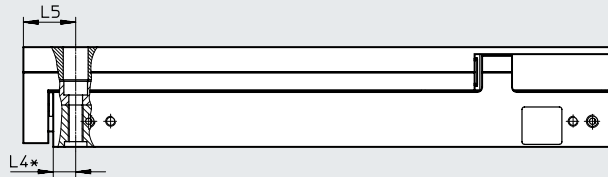
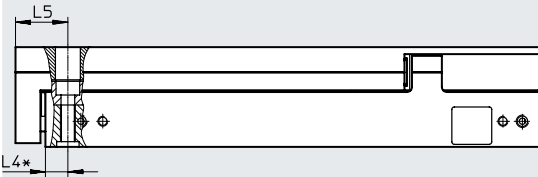
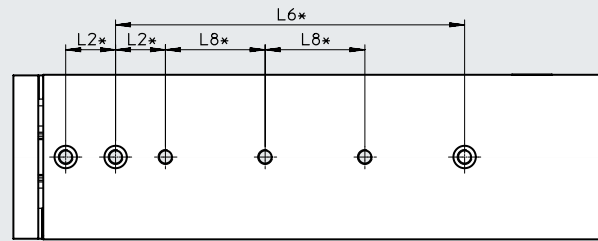
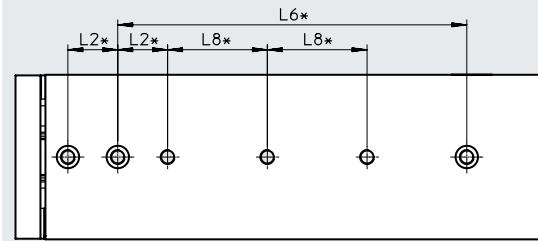

* = ±0.02 mm applies to the centring
 = ±0.1 mm applies to the thread

Size	Stroke [mm]	L1	L2	L3	L4	L5	L6	L7	L8
16	125	32	20	40	9	21	140	40	40
	150								

Data sheet

Hole pattern for mounting threads and centring holes

Download CAD data → www.festo.com

DGST-20-10/20/30/40

DGST-20-50

DGST-20-80

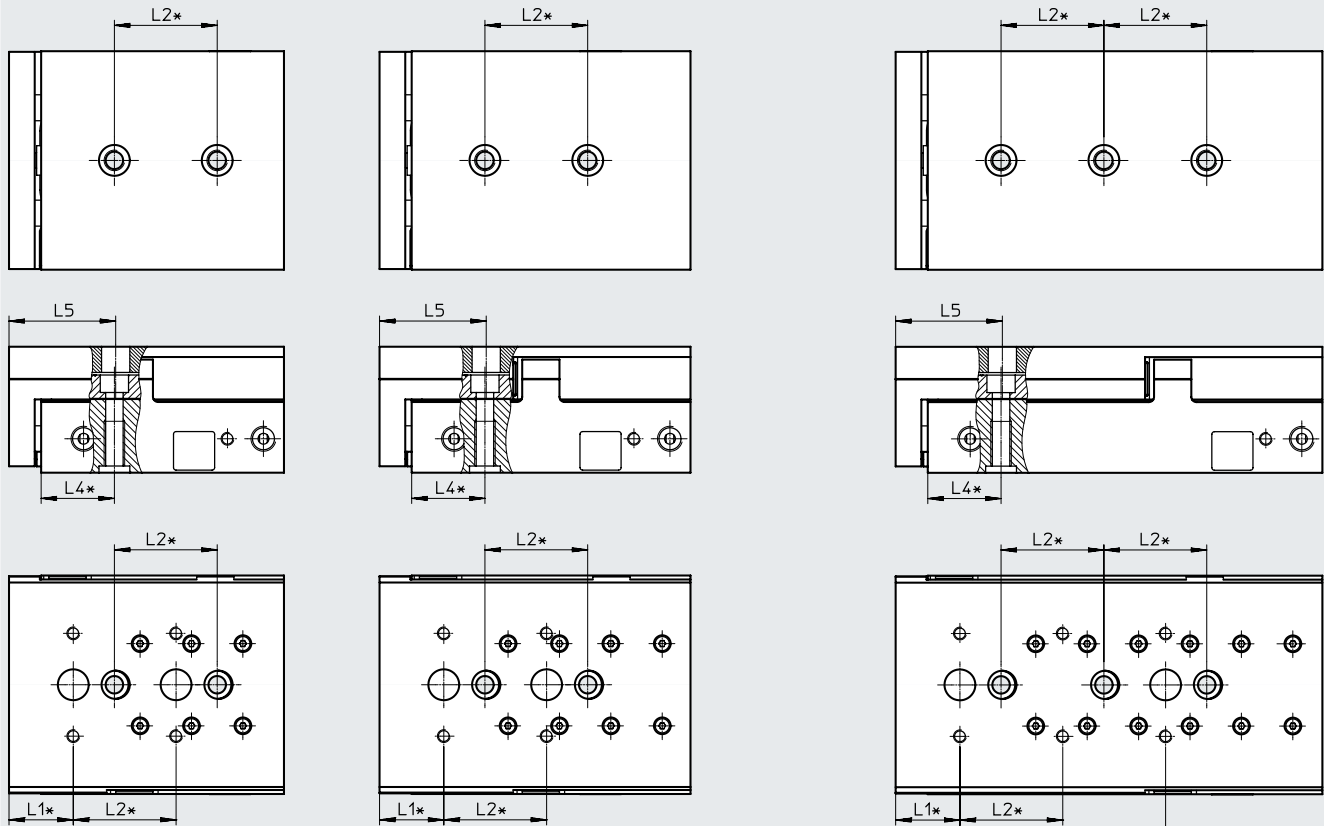

* = ±0.02 mm applies to the centring
 = ±0.1 mm applies to the thread

Size	Stroke [mm]	L1	L2	L3	L4	L5
20	10	25	40	-	28.5	41.5
	20			-		
	30			-		
	40			-		
	50			-		
	80			80		

Data sheet

Hole pattern for mounting threads and centring holes

Download CAD data → www.festo.com

DGST-20-100

DGST-20-125

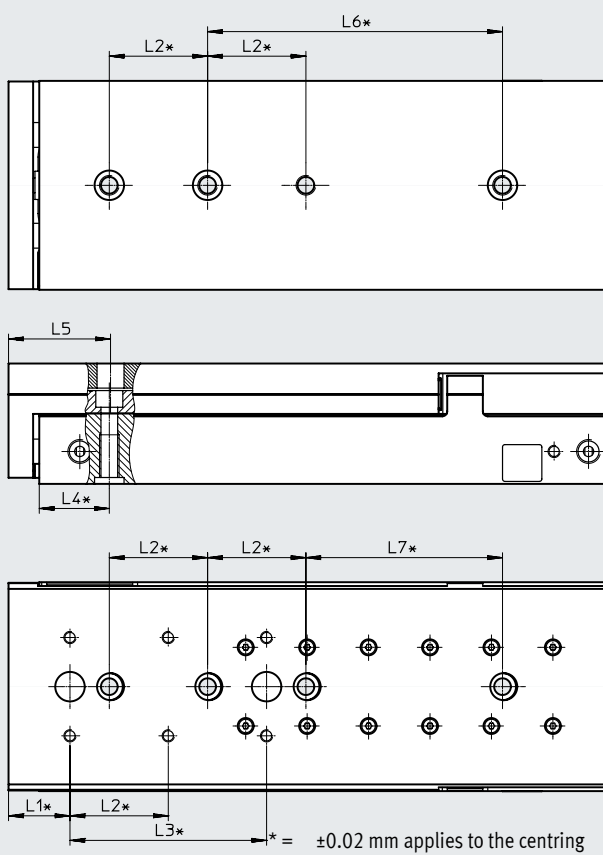
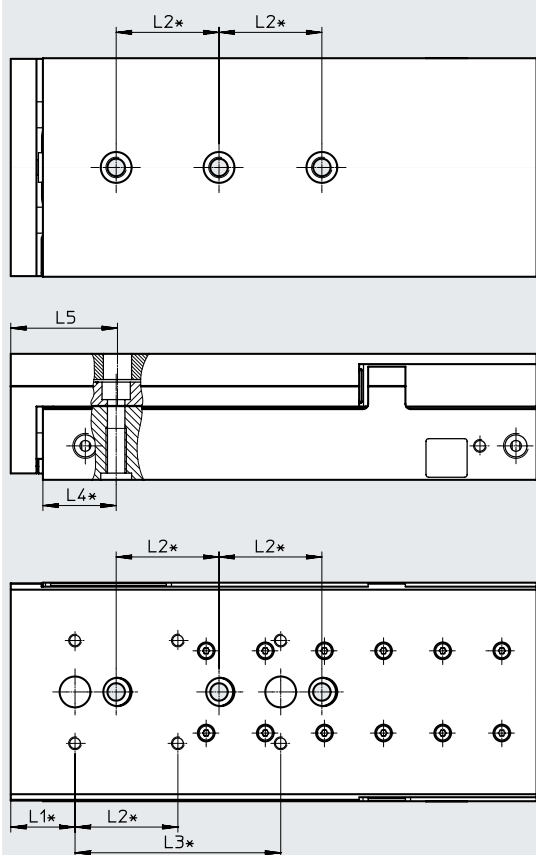

* = ±0.02 mm applies to the centring
 = ±0.1 mm applies to the thread

Size	Stroke [mm]	L1	L2	L3	L4	L5	L6	L7
20	100	25	40	80	28.5	41.5	-	80
	125						120	

Data sheet

Hole pattern for mounting threads and centring holes

Download CAD data → www.festo.com

DGST-20-150

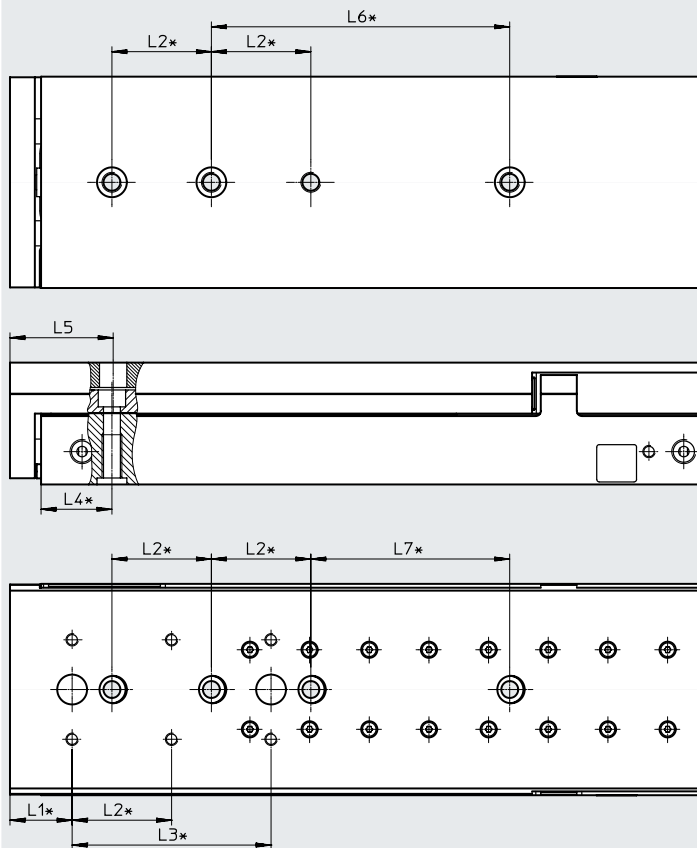

* = ±0.02 mm applies to the centring
 = ±0.1 mm applies to the thread

Size	Stroke [mm]	L1	L2	L3	L4	L5	L6	L7
20	150	25	40	80	28.5	41.5	120	80

Data sheet

Hole pattern for mounting threads and centring holes

Download CAD data → www.festo.com

DGST-20-200

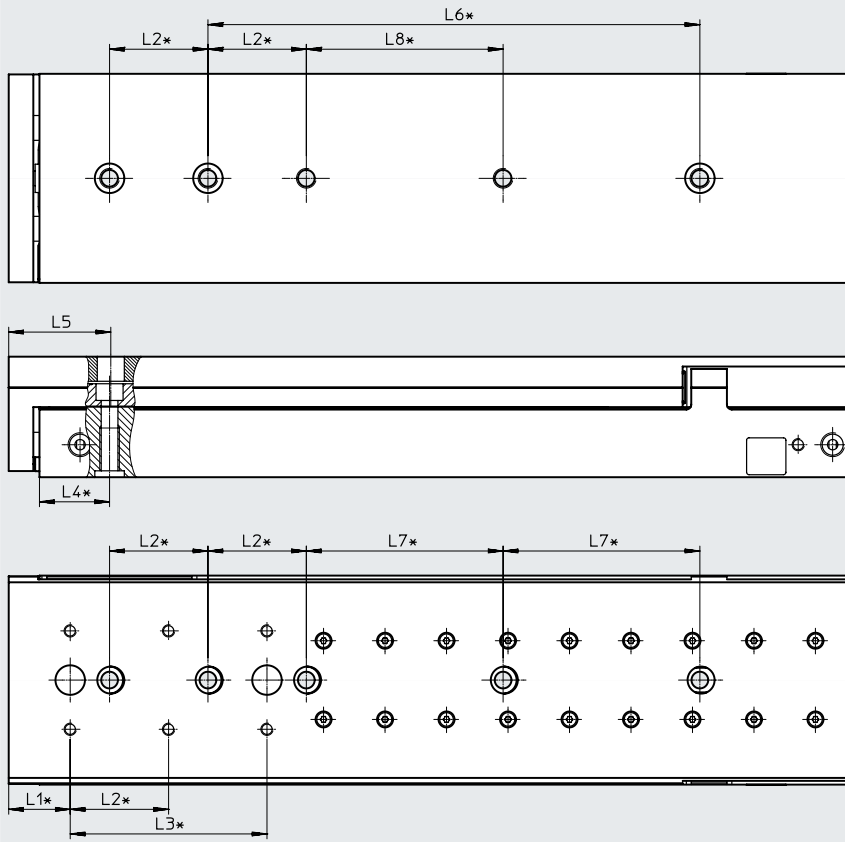

* = ± 0.02 mm applies to the centring
 = ± 0.1 mm applies to the thread

Size	Stroke [mm]	L1	L2	L3	L4	L5	L6	L7	L8
20	200	25	40	80	28.5	41.5	200	80	80

Data sheet

Hole pattern for mounting threads and centring holes

Download CAD data → www.festo.com

DGST-25-10/20/30/40

DGST-25-50

DGST-25-80

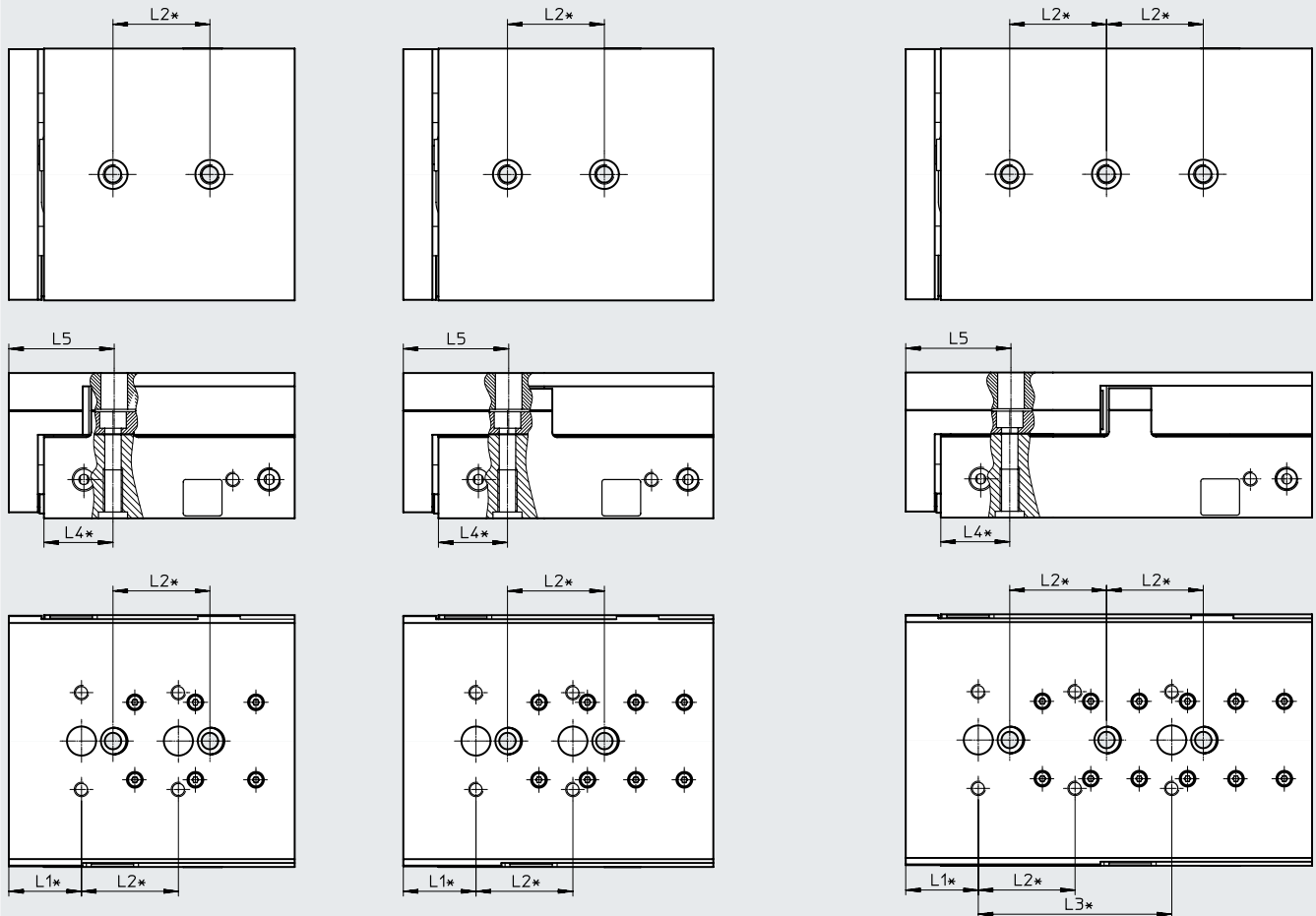

* = ±0.02 mm applies to the centring
 = ±0.1 mm applies to the thread

Size	Stroke [mm]	L1	L2	L3	L4	L5
25	10	30	40	-	28.5	43.5
	20			-		
	30			-		
	40			-		
	50			-		
	80			80		

Data sheet

Hole pattern for mounting threads and centring holes

Download CAD data → www.festo.com

DGST-25-100

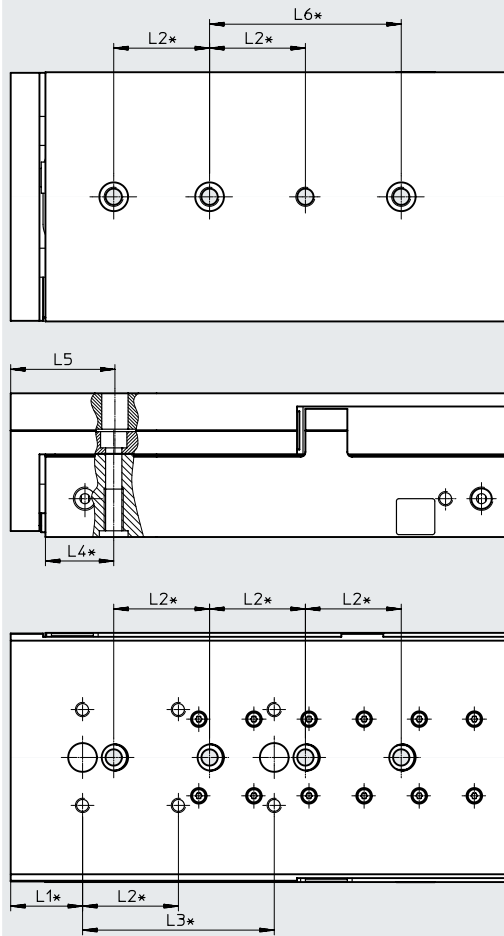

* = ± 0.02 mm applies to the centring
 = ± 0.1 mm applies to the thread

Size	Stroke [mm]	L1	L2	L3	L4	L5	L6	L7
25	100	30	40	80	28.5	43.5	80	80

Data sheet

Hole pattern for mounting threads and centring holes

Download CAD data → www.festo.com

DGST-25-125

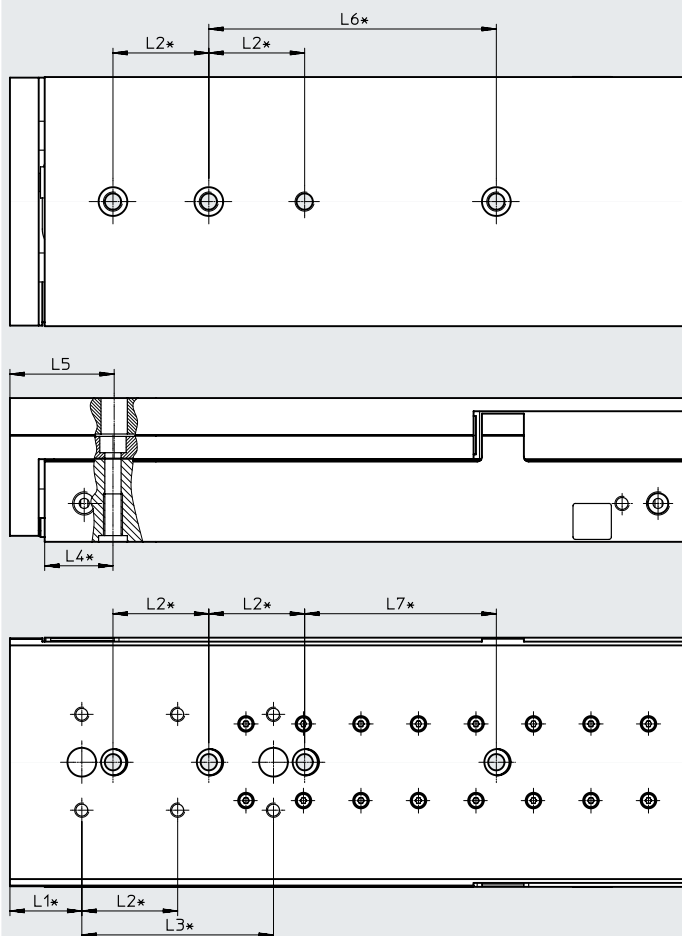

* = ±0.02 mm applies to the centring
 = ±0.1 mm applies to the thread

Size	Stroke [mm]	L1	L2	L3	L4	L5	L6	L7
25	125	30	40	80	28.5	43.5	120	80

Data sheet

Hole pattern for mounting threads and centring holes

Download CAD data → www.festo.com

DGST-25-150

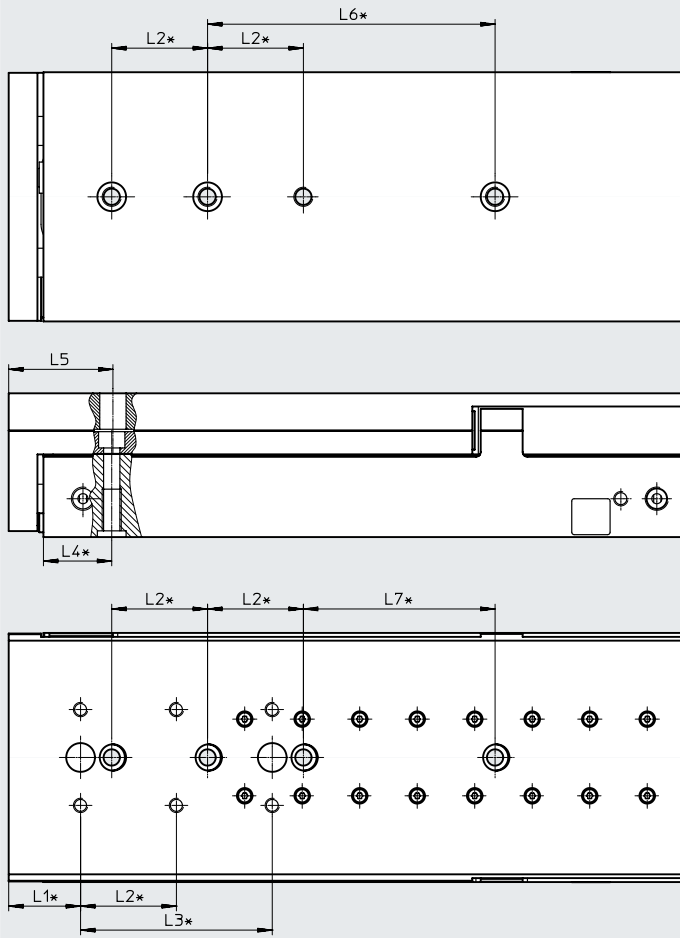

* = ±0.02 mm applies to the centring
 = ±0.1 mm applies to the thread

Size	Stroke [mm]	L1	L2	L3	L4	L5	L6	L7
25	150	30	40	80	28.5	43.5	120	80

Data sheet

Hole pattern for mounting threads and centring holes

Download CAD data → www.festo.com

DGST-25-200

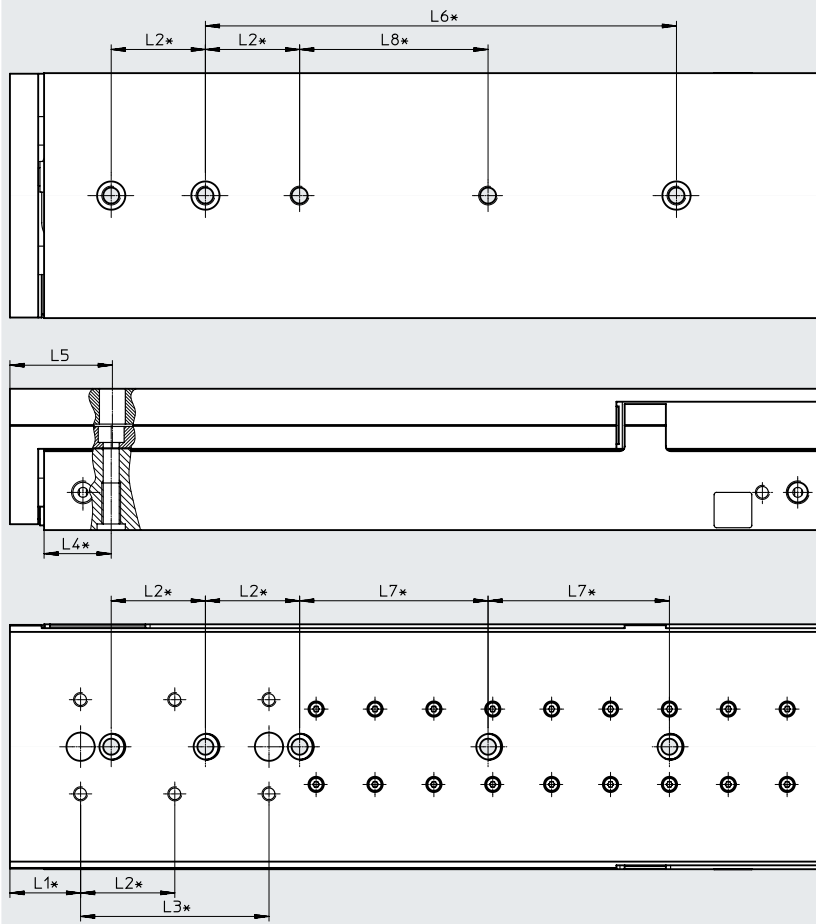

* = ±0.02 mm applies to the centring
 = ±0.1 mm applies to the thread

Size	Stroke [mm]	L1	L2	L3	L4	L5	L6	L7	L8
25	200	30	40	80	28.5	43.5	200	80	80

Data sheet

Dimensions

Download CAD data → www.festo.com

DGST...-P: Setting dimension and projection in the end positions

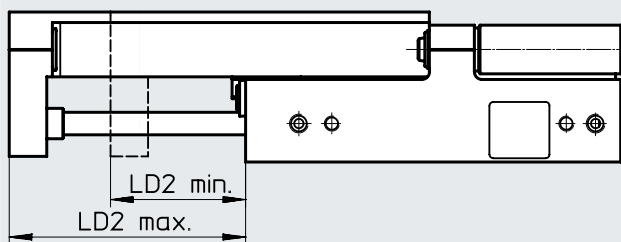
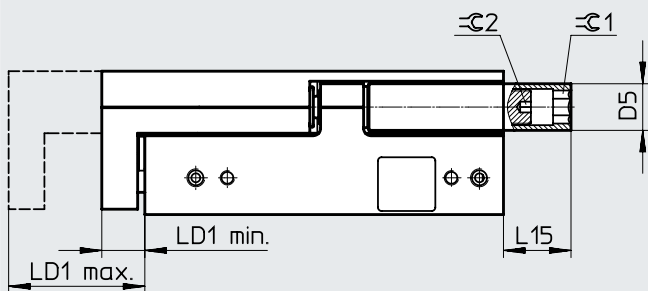

Note
Adjust and secure the cushioning components under pressure.

Size	Stroke [mm]	D5 ∅	L2	LD1 Retracted		L2	LD2 Advanced		L15	∅ 1	∅ 2
			Setting range	min.	max.	Setting range	max.	min.			
6	10	6	11.6	8.6	20.2	13.1	19	8.6	6	3	1.5
	20						29	15.9			
	30						39	25.9			
	40						49	35.9			
	50						59	45.9			
8	10	7	13.4	9.3	22.7	15.3	19	9.3	14.8	4	1.5
	20						29	13.7			
	30						39	23.7			
	40						49	33.7			
	50						59	43.7			
	80						89	73.7	10.8		
10	10	8	14.9	11.3	26.2	16.6	21	11.3	13.9	5	2
	20						31	14.4			
	30						41	24.4			
	40						51	34.4			
	50						61	44.4			
	80						91	74.4	5.9		
	100						111	94.4			
12	10	10	20.8	10.9	31.7	22.1	21	10.9	15.4	6	2.5
	20						31	10.9			
	30						41	18.9			
	40						51	28.9			
	50						61	38.9			
	80						91	68.9			
	100						111	88.9	1.9		

Data sheet

Size	Stroke [mm]	D5 ∅	L2	LD1 Retracted		L2	LD2 Advanced		L15	≈ 1	≈ 2
			Setting range	min.	max.	Setting range	max.	min.			
16	10	13	21.5	12.7	34.2	22.8	23	12.7	17.85	8	3
	20						33	12.7	20.85		
	30						43	20.2	23.85		
	40						53	30.2			
	50						63	40.2	18.85		
	80						93	70.2	10.85		
	100						113	90.2			
	125						138	115.2	0		
	150						163	140.2			
	20						10	15	31.1		
20		33.2	13.1	21.5							
30		43.2	13.1	31.5							
40		53.2	20.3								
50		63.2	30.3	27.5							
80		93.2	60.3	12.5							
100		113.2	80.3								
125		138.2	105.3	0							
150		163.2	130.3								
200		213.2	180.3								
25	10	18	45.4	15.3	60.7	47	25.5	15.3	28.5	10	4
	20						35.5	15.3	38.5		
	30						45.5	15.3			
	40						55.5	15.3	42.5		
	50						65.5	18.5			
	80						95.5	48.5	32.5		
	100						115.5	68.5	13.5		
	125						140.5	93.5			
	150						165.5	118.5	0		
	200						215.5	168.5			

Data sheet

Dimensions

Download CAD data → www.festo.com

DGST...-Y12: Setting dimension and projection in the end positions

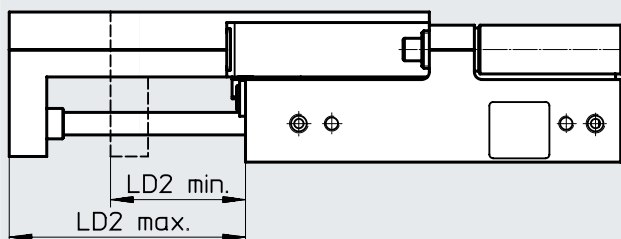
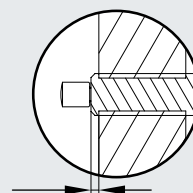
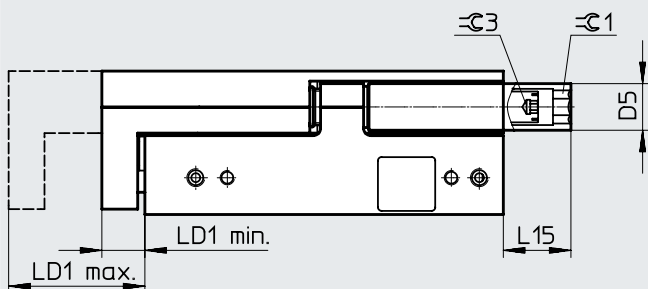

Note
Adjust and secure the cushioning components under pressure.

Size	Stroke [mm]	D5 ∅	L2	LD1 Retracted		L2	LD2 Advanced		L15	Ra 1	Ra 3
			Setting range	min.	max.	Setting range	max.	min.			
6	30	6	9.6	8.6	18.2	11.2	39	27.8	6	3	-1)
	40						49	37.8			
	50						59	47.8			
8	30	7	14.8	9.3	24.1	16.8	39	22.2	14.8	4	2
	40						49	32.2			
	50						59	42.2			
	80						89	72.2	9.8		
10	30	8	14.3	11.3	25.6	16.1	41	24.9	13.9	5	2
	40						51	34.9			
	50						61	44.9			
	80						91	74.9	5.9		
	100						111	94.9			
12	30	10	15.2	10.9	26.1	16.7	41	24.3	15.4	6	2.5
	40						51	34.3			
	50						61	44.3			
	80						91	74.3			
	100						111	94.3			

1) There is a slot in the shock absorber for screwing it in.

Data sheet

Size	Stroke [mm]	D5 ∅	L2	LD1 Retracted		L2	LD2 Advanced		L15	≈ 1	≈ 3
			Setting range	min.	max.	Setting range	max.	min.			
16	30	13	15.5	12.7	28.2	16.9	43	26.1	23.85	8	3
	40						53	36.1			
	50						63	46.1			
	80						93	76.1	10.85		
	100						113	96.1			
	125						138	121.1	0		
	150						163	146.1			
20	30	15	25.9	13.1	39	27.7	43.2	21.1	31.5	10	4
	40						53.2	25.5			
	50						63.2	35.5	12.5		
	80						93.2	65.5			
	100						113.2	85.5	0		
	125						138.2	110.5			
	150						163.2	135.5			
	200						213.2	185.5			
25	30	18	30.4	15.3	45.7	32	45.5	25.3	42.5	10	4
	40						55.5	25.3			
	50						65.5	33.5			
	80						95.5	63.5	32.5		
	100						115.5	83.5			
	125						140.5	108.5			
	150						165.5	133.5	0		
	200						215.5	183.5			

1) There is a slot in the shock absorber for screwing it in.

Data sheet

Ordering data							
Size	Stroke [mm]	Part no.	Type	Size	Stroke [mm]	Part no.	Type
With cushioning E1				With cushioning P			
6	10	8078828	DGST-6-10-E1A	6	10	8085105	DGST-6-10-PA
	20	8078829	DGST-6-20-E1A		20	8085106	DGST-6-20-PA
	30	8078830	DGST-6-30-E1A		30	8085107	DGST-6-30-PA
	40	8078831	DGST-6-40-E1A		40	8085108	DGST-6-40-PA
	50	8078832	DGST-6-50-E1A		50	8085109	DGST-6-50-PA
8	10	★ 8078833	DGST-8-10-E1A	8	10	8085110	DGST-8-10-PA
	20	★ 8078834	DGST-8-20-E1A		20	8085111	DGST-8-20-PA
	30	★ 8078835	DGST-8-30-E1A		30	8085112	DGST-8-30-PA
	40	★ 8078836	DGST-8-40-E1A		40	8085113	DGST-8-40-PA
	50	★ 8078837	DGST-8-50-E1A		50	8085114	DGST-8-50-PA
10	80	★ 8078838	DGST-8-80-E1A	80	8085115	DGST-8-80-PA	
	10	★ 8078839	DGST-10-10-E1A	10	10	8085116	DGST-10-10-PA
	20	★ 8078840	DGST-10-20-E1A		20	8085117	DGST-10-20-PA
	30	★ 8078841	DGST-10-30-E1A		30	8085118	DGST-10-30-PA
	40	★ 8078842	DGST-10-40-E1A		40	8085119	DGST-10-40-PA
50	★ 8078843	DGST-10-50-E1A	50		8085120	DGST-10-50-PA	
12	80	★ 8078844	DGST-10-80-E1A	80	8085121	DGST-10-80-PA	
	100	★ 8078845	DGST-10-100-E1A	100	8085122	DGST-10-100-PA	
	10	★ 8078846	DGST-12-10-E1A	12	10	8085123	DGST-12-10-PA
	20	★ 8078847	DGST-12-20-E1A		20	8085124	DGST-12-20-PA
	30	★ 8078848	DGST-12-30-E1A		30	8085125	DGST-12-30-PA
40	★ 8078849	DGST-12-40-E1A	40		8085126	DGST-12-40-PA	
50	★ 8078850	DGST-12-50-E1A	50		8085127	DGST-12-50-PA	
16	80	★ 8078851	DGST-12-80-E1A	80	8085128	DGST-12-80-PA	
	100	★ 8078852	DGST-12-100-E1A	100	8085129	DGST-12-100-PA	
	10	★ 8078853	DGST-16-10-E1A	16	10	8085130	DGST-16-10-PA
	20	★ 8078854	DGST-16-20-E1A		20	8085131	DGST-16-20-PA
	30	★ 8078855	DGST-16-30-E1A		30	8085132	DGST-16-30-PA
40	★ 8078856	DGST-16-40-E1A	40		8085133	DGST-16-40-PA	
50	★ 8078857	DGST-16-50-E1A	50		8085134	DGST-16-50-PA	
16	80	★ 8078858	DGST-16-80-E1A	80	8085135	DGST-16-80-PA	
	100	★ 8078859	DGST-16-100-E1A	100	8085136	DGST-16-100-PA	
	125	8078860	DGST-16-125-E1A	125	8085137	DGST-16-125-PA	
	150	8078861	DGST-16-150-E1A	150	8085138	DGST-16-150-PA	

Data sheet

Ordering data							
Size	Stroke [mm]	Part no.	Type	Size	Stroke [mm]	Part no.	Type
With cushioning E1				With cushioning P			
20	10	★ 8078862	DGST-20-10-E1A	20	10	8085139	DGST-20-10-PA
	20	★ 8078863	DGST-20-20-E1A		20	8085140	DGST-20-20-PA
	30	★ 8078864	DGST-20-30-E1A		30	8085141	DGST-20-30-PA
	40	★ 8078865	DGST-20-40-E1A		40	8085142	DGST-20-40-PA
	50	★ 8078866	DGST-20-50-E1A		50	8085143	DGST-20-50-PA
	80	★ 8078867	DGST-20-80-E1A		80	8085144	DGST-20-80-PA
	100	★ 8078868	DGST-20-100-E1A		100	8085145	DGST-20-100-PA
	125	8078869	DGST-20-125-E1A		125	8085146	DGST-20-125-PA
	150	8078870	DGST-20-150-E1A		150	8085147	DGST-20-150-PA
200	8078871	DGST-20-200-E1A	200	8085148	DGST-20-200-PA		
25	10	8078872	DGST-25-10-E1A	25	10	8085149	DGST-25-10-PA
	20	8078873	DGST-25-20-E1A		20	8085150	DGST-25-20-PA
	30	8078874	DGST-25-30-E1A		30	8085151	DGST-25-30-PA
	40	8078875	DGST-25-40-E1A		40	8085152	DGST-25-40-PA
	50	8078876	DGST-25-50-E1A		50	8085153	DGST-25-50-PA
	80	8078877	DGST-25-80-E1A		80	8085154	DGST-25-80-PA
	100	8078878	DGST-25-100-E1A		100	8085155	DGST-25-100-PA
	125	8078879	DGST-25-125-E1A		125	8085156	DGST-25-125-PA
	150	8078880	DGST-25-150-E1A		150	8085157	DGST-25-150-PA
200	8078881	DGST-25-200-E1A	200	8085158	DGST-25-200-PA		

Data sheet

Ordering data			
Size	Stroke [mm]	Part no.	Type
With cushioning Y12			
6	30	8085159	DGST-6-30-Y12A
	40	8085160	DGST-6-40-Y12A
	50	8085161	DGST-6-50-Y12A
8	30	8085162	DGST-8-30-Y12A
	40	8085163	DGST-8-40-Y12A
	50	8085164	DGST-8-50-Y12A
	80	8085165	DGST-8-80-Y12A
10	30	8085166	DGST-10-30-Y12A
	40	8085167	DGST-10-40-Y12A
	50	8085168	DGST-10-50-Y12A
	80	8085169	DGST-10-80-Y12A
	100	8085170	DGST-10-100-Y12A
12	30	8085171	DGST-12-30-Y12A
	40	8085172	DGST-12-40-Y12A
	50	8085173	DGST-12-50-Y12A
	80	8085174	DGST-12-80-Y12A
	100	8085175	DGST-12-100-Y12A
16	30	8085176	DGST-16-30-Y12A
	40	8085177	DGST-16-40-Y12A
	50	8085178	DGST-16-50-Y12A
	80	8085179	DGST-16-80-Y12A
	100	8085180	DGST-16-100-Y12A
	125	8085181	DGST-16-125-Y12A
	150	8085182	DGST-16-150-Y12A
20	30	8085183	DGST-20-30-Y12A
	40	8085184	DGST-20-40-Y12A
	50	8085185	DGST-20-50-Y12A
	80	8085186	DGST-20-80-Y12A
	100	8085187	DGST-20-100-Y12A
	125	8085188	DGST-20-125-Y12A
	150	8085189	DGST-20-150-Y12A
	200	8085190	DGST-20-200-Y12A
25	30	8085191	DGST-25-30-Y12A
	40	8085192	DGST-25-40-Y12A
	50	8085193	DGST-25-50-Y12A
	80	8085194	DGST-25-80-Y12A
	100	8085195	DGST-25-100-Y12A
	125	8085196	DGST-25-125-Y12A
	150	8085197	DGST-25-150-Y12A
	200	8085198	DGST-25-200-Y12A

Ordering data – Modular product system

Ordering table										
Piston diameter	6	8	10	12	16	20	25	Conditions	Code	Enter code
Module no.	8073891	8073892	8073893	8073894	8073895	8073896	8073897			
Function	Mini slide								DGST	DGST
Piston diameter [mm]	6	8	10	12	16	20	25		-...	
Stroke [mm]	10	10	10	10	10	10	10		-...	
	20	20	20	20	20	20	20		-...	
	30	30	30	30	30	30	30		-...	
	40	40	40	40	40	40	40		-...	
	50	50	50	50	50	50	50		-...	
	-	80	80	80	80	80	80		-...	
	-	-	100	100	100	100	100		-...	
	-	-	-	-	125	125	125		-...	
	-	-	-	-	150	150	150		-...	
-	-	-	-	-	200	200		-...		
Version	Standard									
	Mirror-inverted								-L	
Cushioning	Elastic cushioning rings/pads at both ends								-P	
	Elastomer cushioning, at both ends, stroke not adjustable								-E1	
	Shock absorber, self-adjusting, linear, at both ends, external							[1]	-Y12	
Position sensing	Via proximity sensor								A	
Special material properties	None									
	Recommended for production plants for the manufacture of Li-Ion batteries							[2]	-F1A	

1) Y12 Only in combination with a stroke of min. 30 mm

2) F1A Not in combination with Y12 and piston diameter 6, 8, 10, 20, 25

Accessories

Connection set DADG-AK-G8-...

Material:
 Adapter: Epoxy resin
 Seals: NBR
 Screws: Coated steel

Free of copper and PTFE

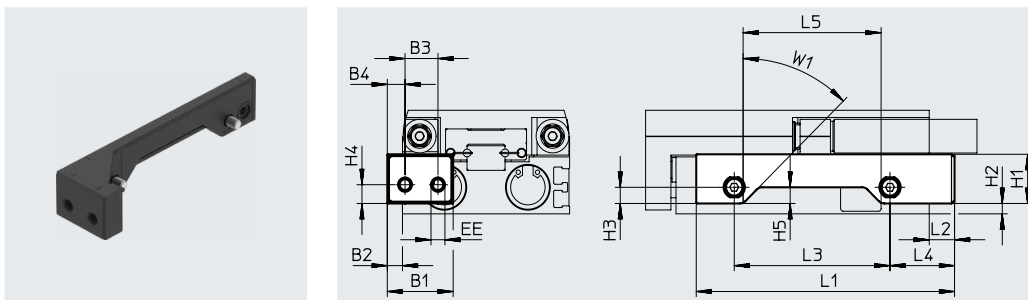

Dimensions and ordering data											
For size [mm]	Stroke [mm]	B1	B2	B3	B4	EE	H1	H2	H3	H4	H5
6	20 ... 50	21	4	10.5	5.5	M5	11.6	0.1	4.4	5	2.9
	20	26	6	13	6.5	M5	13.6	0.3	5.3	5.2	3.3
30 ... 80	5.3										
10	10 ... 20	26	6	13	6.5	M5	16.1	0.7	6.4	6.4	3.9
	30 ... 100										6.4
12	10	26	6	13	6.5	M5	18.4	2.6	6.4	6.4	3.9
	20 ... 100										6.4

Dimensions and ordering data											
For size [mm]	Stroke [mm]	L1	L2	L3	L4	L5	W1	CRC ¹⁾	Weight [g]	Part no.	Type
6	20	53.5	8	21.9	20.7	17	45°	1	4.7	8152357	DADG-AK-G8-6-20
	30	63.5		31.9		27		1	5.1	8152358	DADG-AK-G8-6-30
	40	73.5		41.9		37		1	5.4	8152359	DADG-AK-G8-6-40
	50	90.5		58.9		54		1	6	8152360	DADG-AK-G8-6-50
8	20	61	10	23	23.5	17.4	45°	1	8.3	8152361	DADG-AK-G8-8-20
	30	71		33		27.4		1	8.7	8152362	DADG-AK-G8-8-30
	40	81		43		37.4		1	9.2	8152363	DADG-AK-G8-8-40
	50	95		57		51.4		1	9.9	8152364	DADG-AK-G8-8-50
	80	126		88		82.4		1	11.3	8152365	DADG-AK-G8-8-80
10	10	64	10	22.5	25.6	16.7	45°	1	11	8152366	DADG-AK-G8-10-10
	20	66		24.5		18.7		1	11.2	8152367	DADG-AK-G8-10-20
	30	76		34.5		28.7		1	11.6	8152368	DADG-AK-G8-10-30
	40	86		44.5		38.7		1	12.1	8152369	DADG-AK-G8-10-40
	50	96		54.5		48.7		1	12.6	8152370	DADG-AK-G8-10-50
	80	134		92.5		86.7		1	14.5	8152371	DADG-AK-G8-10-80
	100	154		112.5		106.7		1	15.5	8152372	DADG-AK-G8-10-100
12	10	62	10	20.7	25.8	14.9	45°	1	12.2	8152373	DADG-AK-G8-12-10
	20	72		30.7		24.9		1	12.9	8152374	DADG-AK-G8-12-20
	30	82		40.7		34.9		1	13.6	8152375	DADG-AK-G8-12-30
	40	92		50.7		44.9		1	14.2	8152376	DADG-AK-G8-12-40
	50	102		60.7		54.9		1	14.9	8152377	DADG-AK-G8-12-50
	80	132		90.7		84.9		1	16.9	8152378	DADG-AK-G8-12-80
	100	165.5		124.2		118.4		1	19.2	8152379	DADG-AK-G8-12-100

1) Corrosion resistance class CRC 1 to Festo standard FN 940070
 Low corrosion stress. Dry internal application or transport and storage protection. Also applies to parts behind coverings, in the non-visible interior area, or parts that are covered in the application (e.g. drive trunnions).

Accessories

Dimensions and ordering data											
For size [mm]	Stroke [mm]	B1	B2	B3	B4	EE	H1	H2	H3	H4	H5
16	10 ... 20	26	6	13	7	M5	19	4	6.3	7.3	3.6
	30 ... 100										6.3
	125 ... 150										2
20	10 ... 30	45	9	22	13	G1/8	24.8	3.7	9.5	9.5	5.5
	40 ... 150		10								9.5
	200										8.6
25	10 ... 30	45	9	22	13	G1/8	28.2	6.5	9.5	9.5	5
	40 ... 150		10								9.5
	200										12

Dimensions and ordering data											
Size [mm]	Stroke [mm]	L1	L2	L3	L4	L5	W1	CRC ¹⁾	Weight [g]	Part no.	Type
16	10	63	10	22.5	25.5	15.5	45°	1	12.9	8152380	DADG-AK-G8-16-10
	20	70		29.5		22.5		1	13.5	8152381	DADG-AK-G8-16-20
	30	77		36.5		29.5		1	13.8	8152382	DADG-AK-G8-16-30
	40	87		46.5		39.5		1	14.5	8152383	DADG-AK-G8-16-40
	50	102		61.5		54.5		1	15.5	8152384	DADG-AK-G8-16-50
	80	140		100.5	93.5	1		17.8	8152385	DADG-AK-G8-16-80	
	100	160		120.5	113.5	1		19.1	8152386	DADG-AK-G8-16-100	
	125	200		160.5	153.5	1		28.2	8159793	DADG-AK-G8-16-125	
	150	225		185.5	178.5	1		31	8159794	DADG-AK-G8-16-150	
	20	10/20/30		92.6	15	32		37	23.4	45°	1
40		102.6	42	33.4		1	37.5		8152390		DADG-AK-G8-20-40
50		116.6	56	47.4		1	39.2		8152391		DADG-AK-G8-20-50
80		161.6	101	92.4		1	44.7		8152392		DADG-AK-G8-20-80
100		200.1	139.5	130.9		1	49.4		8159795		DADG-AK-G8-20-100
125		239.6	179	170.4		1	54.2		8159796		DADG-AK-G8-20-125
150		274.6	214	205.4		1	58.6		8159797		DADG-AK-G8-20-150
200		338.6	278	270.1		1	80.2		8159882		DADG-AK-G8-20-200
25	10/20	95.6	15	30.5	40.5	22.6	45°	1	43.7	8152397	DADG-AK-G8-25-10/20
	30	101.6		36.5		28.6		1	44.8	8152398	DADG-AK-G8-25-30
	40	111.6		46.5		38.6		1	46.1	8152399	DADG-AK-G8-25-40
	50	121.6		56.5		48.6		1	47.5	8152400	DADG-AK-G8-25-50
	80	161.6		96.5		88.6		1	53.4	8152401	DADG-AK-G8-25-80
	100	200.6		135.5		127.6		1	59	8159816	DADG-AK-G8-25-100
	125	239.6		174.5		166.6		1	64.7	8159817	DADG-AK-G8-25-125
	150	274.6		209.5		201.6		1	69.8	8159818	DADG-AK-G8-25-150
200	338.6	273.5	265.5	1	87.7	8159883	DADG-AK-G8-25-200				





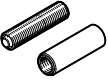
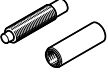

1) Corrosion resistance class CRC 1 to Festo standard FN 940070

Low corrosion stress. Dry internal application or transport and storage protection. Also applies to parts behind coverings, in the non-visible interior area, or parts that are covered in the application (e.g. drive trunnions).

Accessories

Ordering data – Shock absorbers			
	For size	Description	Part no. Type
For DGST...-P Data sheets → Internet: dyef			
	6	<ul style="list-style-type: none"> • Scope of delivery: 1 cushioning element and 1 threaded sleeve • Elastic cushioning at both ends, self-adjusting, with end-position adjustment • Included in the scope of delivery for DGST...-P (2 pieces) 	★ 8073902 DYEF-G8-M4-Y1
	8		8131070 DYEF-G8-M4-Y1-F1A
	10		★ 8073903 DYEF-G8-M5-Y1
	12		8131071 DYEF-G8-M5-Y1-F1A
	16		★ 8073904 DYEF-G8-M6-Y1
	20		8131072 DYEF-G8-M6-Y1-F1A
	25		★ 8073905 DYEF-G8-M8-Y1
			8131073 DYEF-G8-M8-Y1-F1A
			★ 8073906 DYEF-G8-M10-Y1
	8131074 DYEF-G8-M10-Y1-F1A		
	★ 8073907 DYEF-G8-M12-Y1		
	8132355 DYEF-G8-M12-Y1-F1A		
	★ 8073908 DYEF-G8-M14-Y1		
	8132356 DYEF-G8-M14-Y1-F1A		
For DGST...-Y12 Data sheets → Internet: dyss			
	6	<ul style="list-style-type: none"> • Scope of delivery: 1 cushioning element and 1 threaded sleeve • Shock absorbers at both ends, self-adjusting, with end-position adjustment • Included in the scope of delivery for DGST...-Y12 (2 pieces) • Only possible from a stroke of 30 mm • Set minimum stroke ≥ 2x stroke length 	★ 8073911 DYSS-G8-2-4-Y1F
	8		★ 8111383 DYSS-G8-3-4-Y1F-G2
	10		★ 8111384 DYSS-G8-4-4-Y1F-G2
	12		★ 8073914 DYSS-G8-5-5-Y1F
	16		8119983 DYSS-G8-5-5-Y1F-F1A
	20		★ 8073915 DYSS-G8-7-5-Y1F
	25		8119984 DYSS-G8-7-5-Y1F-F1A
			★ 8073916 DYSS-G8-8-8-Y1F
	★ 8073917 DYSS-G8-10-10-Y1F		

Accessories

Ordering data		For size	Description	Part no.	Type	PU ¹⁾
Centring sleeve/Centring pin ZBH, ZBS			Data sheets → Internet: zbh			
	6, 8, 10, 12, 16	For centring loads and attachments on the slide	189652	ZBH-5	10	
	20, 25		189653	ZBH-12		
	6	For centring loads and attachments on the yoke plate	525273	ZBS-2		
	8, 10		189652	ZBH-5		
	12, 16		186717	ZBH-7		
	20, 25		189653	ZBH-12		
	6, 8		For centring the mini slide during mounting	8119593		ZBH-5-M4
	10, 12	186717		ZBH-7		
	16	150927		ZBH-9		
	20, 25	189653		ZBH-12		
Connector sleeve ZBV			Data sheets → Internet: zbv			
	20	For centring loads and attachments on the yoke plate	548806	ZBV-12-9	10	
One-way flow control valve GRLA			Data sheets → Internet: grla			
	6	For speed regulation	175041	GRLA-M3-QS-3	1	
	8, 10, 12, 16		★ 193139	GRLA-M5-QS-6-D		
	20, 25		★ 193145	GRLA-1/8-QS-8-D		
One-way flow control valve GRLA for Anschlussbausatz DADG-AK-G8-6-...			Data sheets → Internet: grla			
	6	For speed regulation	175053	GRLA-M5-QS-3-LF-C	1	
Push-in fitting QSM			Data sheets → Internet: qs			
	6	For connecting compressed air tubing with standard O.D.	★ 153303	QSM-M3-4	10	
	8, 10, 12, 16		★ 153304	QSM-M5-4		
	20, 25		★ 153307	QSM-1/8-6		
Push-in fitting QSM for connection set DADG-AK-G8-6-...			Data sheets → Internet: qs			
	6	For connecting compressed air tubing with standard O.D.	153302	QSM-M5-3	10	
			153313	QSM-M5-3-I		

1) Packaging unit

Accessories

Proximity sensor for size 6 ... 12

Ordering data – Proximity sensor for C-slot, magneto-resistive

Data sheets → Internet: smt

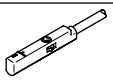
	Type of mounting	Switching output	Electrical connection, outlet direction of connection	Cable length [m]	Part no.	Type
N/O contact						
	Inserted in the slot from above	PNP	Cable, 3-wire, in-line	2.5	★ 551373	SMT-10M-PS-24V-E-2,5-L-OE
			Plug M8x1, 3-pin, in-line	0.3	★ 551375	SMT-10M-PS-24V-E-0,3-L-M8D
			Plug M8x1, 3-pin, lateral	0.3	551376	SMT-10M-PS-24V-E-0,3-Q-M8D
		NPN	Cable, 3-wire,	2.5	★ 551377	SMT-10M-NS-24V-E-2,5-L-OE
			Cable, 3-wire,	2.5	551378	SMT-10M-NS-24V-E-2,5-Q-OE
			Plug M8x1, 3-pin, in-line	0.3	★ 551379	SMT-10M-NS-24V-E-0,3-L-M8D
			Plug M8x1, 3-pin, lateral	0.3	551380	SMT-10M-NS-24V-E-0,3-Q-M8D

Proximity sensor for size 16 ... 25

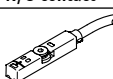

Ordering data – Proximity sensor for T-slot, magneto-resistive

Data sheets → Internet: smt

	Type of mounting	Switching output	Electrical connection	Cable length [m]	Part no.	Type
N/O contact						
	Inserted in the slot from above, flush with the cylinder profile, short design	PNP	Cable, 3-wire	2.5	★ 574335	S7 SMT-8M-A-PS-24V-E-2,5-OE
			Plug M8x1, 3-pin	0.3	★ 574334	S6 SMT-8M-A-PS-24V-E-0,3-M8
		NPN	Cable, 3-wire	2.5	★ 574338	SMT-8M-A-NS-24V-E-2,5-OE
			Plug M8x1, 3-pin	0.3	★ 574339	S9 SMT-8M-A-NS-24V-E-0,3-M8

Ordering data – Connecting cables

Data sheets → Internet: nebu

	Electrical connection, left	Electrical connection, right	Cable length [m]	Part no.	Type
	Straight socket, M8x1, 3-pin	Cable, open end, 3-wire	2.5	★ 541333	NEBU-M8G3-K-2.5-LE3
			5	★ 541334	NEBU-M8G3-K-5-LE3
	Angled socket, M8x1, 3-pin	Cable, open end, 3-wire	2.5	★ 541338	NEBU-M8W3-K-2.5-LE3
			5	★ 541341	NEBU-M8W3-K-5-LE3

Accessories

Position transmitter

The position transmitter continuously senses the position of the piston.

It has an analogue output with an output signal relative to the piston position.

Ordering data – Position transmitter for T-slot

Data sheets → Internet: position transmitter

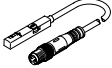
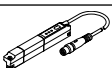
	For \varnothing	Position measuring range	Analogue output		Type of mounting	Electrical connection	Cable length [m]	Part no.	Type
			[V]	[mA]					
	16 ... 25	0 ... 40	0 ... 10	–	Inserted in the slot from above	Plug M8x1, 4-pin, in-line	0.3	553744	SMAT-8M-U-E-0,3-M8D
	16 ... 25	0 ... 50	–	4 ... 20	Inserted in the slot from above	Plug M8x1, 4-pin, in-line	0.3	1531265	SDAT-MHS-M50-1L-SA-E-0.3-M8
		0 ... 80						1531266	SDAT-MHS-M80-1L-SA-E-0.3-M8
		0 ... 100						1531267	SDAT-MHS-M100-1L-SA-E-0.3-M8
		0 ... 125						1531268	SDAT-MHS-M125-1L-SA-E-0.3-M8
		0 ... 160						1531269	SDAT-MHS-M160-1L-SA-E-0.3-M8

Ordering data – Position transmitter for T-slot

Data sheets → Internet: sdas

	Position measuring range	Description	Type of mounting	Electrical connection	Cable length [m]	Part no.	Type

Ordering data – Connecting cables

Data sheets → Internet: nebu

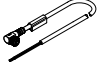
	Electrical connection, left	Electrical connection, right	Cable length [m]	Part no.	Type
5	541343	NEBU-M8G4-K-5-LE4			
	Angled socket, M8x1, 4-pin	Cable, open end, 4-wire	2.5	541344	NEBU-M8W4-K-2.5-LE4
5			541345	NEBU-M8W4-K-5-LE4	