



- Piston rod secured against rotation by means of guide rods and yoke plate
- Profile slots for proximity sensors
- Extensive range of accessories

Specified types in accordance with ATEX directive for potentially explosive atmospheres

→ www.festo.com/en/ex

Compact cylinders ADVUL

Peripherals overview

FESTO

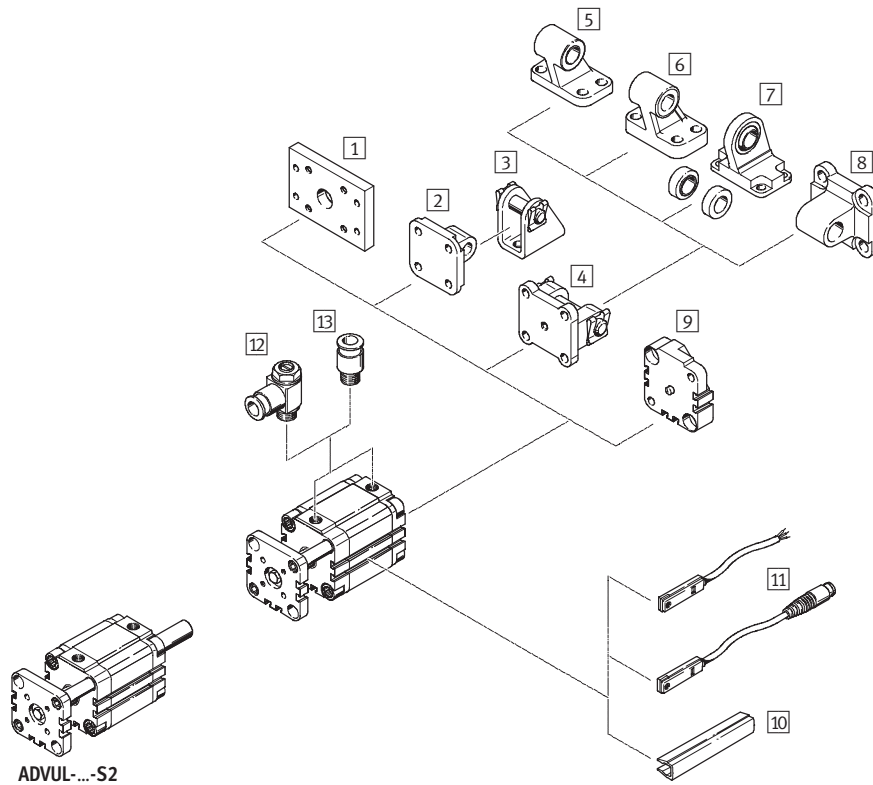

ADVUL-...-S2

Mounting attachments and accessories					
	Brief description	ADVUL		→ Page/Internet	
			S2		
1	Flange mounting FUA	For end caps	■	■	12
2	Swivel flange SUA for Ø 12 ... 25	For end caps	■	-	13
3	Clevis foot LBN	-	■	-	15
4	Swivel flange SUA for Ø 32 ... 100	For end caps	■	-	13
5	Clevis foot LN	-	■	-	15
6	Clevis foot LNG	-	■	-	15
7	Clevis foot LSN	With spherical bearing	■	-	15
8	Swivel flange SNCL	-	■	-	15
9	Adapter kit DPVU	For connecting two cylinders with identical piston diameter to form a multi-position cylinder	■	-	14
10	Slot cover ABP-5-S	To protect the sensor cable and keep dirt out of the sensor slots	■	■	16
11	Proximity sensor SME/SMT-8	Can be integrated in the cylinder profile barrel	■	■	16
12	One-way flow control valve GRLA	To regulate speed	■	■	15
13	Push-in fitting QS	For connecting compressed air tubing with standard external diameters	■	■	quick star

Compact cylinders ADVUL

Type codes

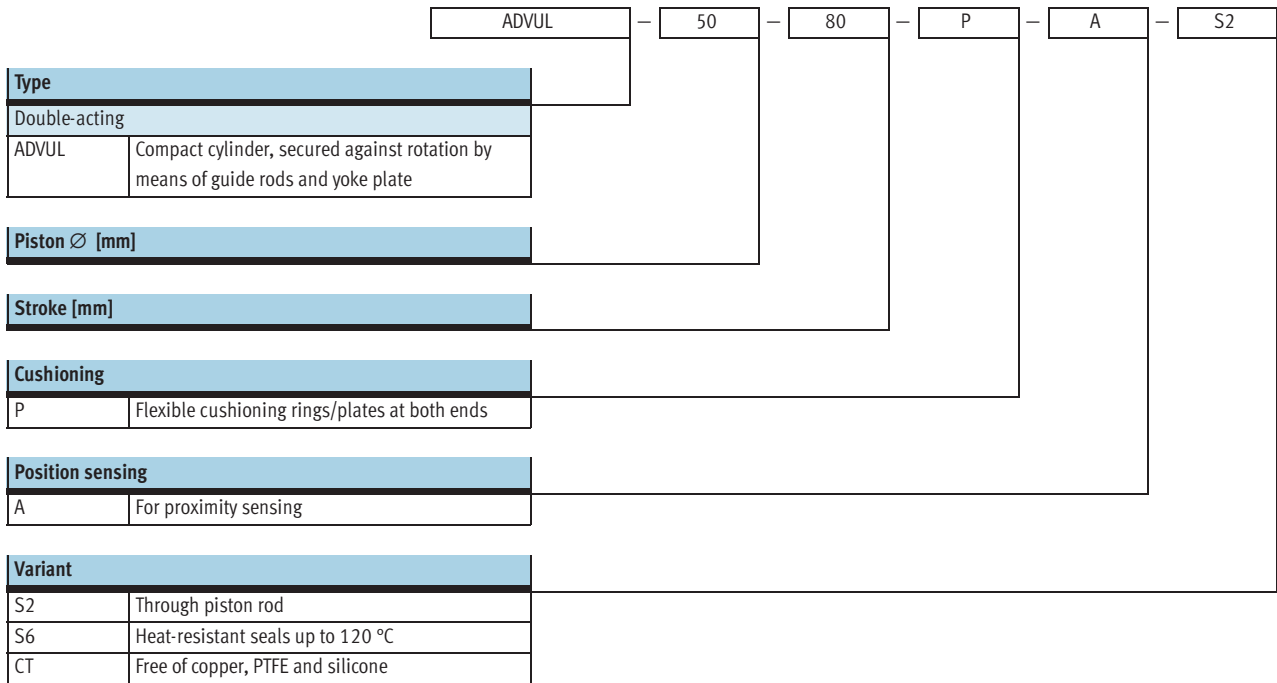

Compact cylinders ADVUL

Technical data

FESTO

Function

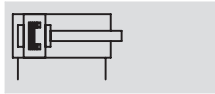

- Ø - Diameter
12 ... 100 mm

- | - Stroke length
1 ... 400 mm

-  - www.festo.com

Wearing parts kits, see
→ 11

Variants

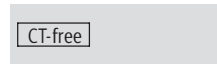

S2

S6

CT



ADVUL-...-P-A



ADVUL-...-P-A-S2

General technical data										
Piston Ø	12	16	20	25	32	40	50	63	80	100
Pneumatic connection	M5	M5	M5	M5	G1/8	G1/8	G1/8	G1/8	G1/8	G1/4
Operating medium	Filtered compressed air, lubricated or unlubricated									
Constructional design	Piston									
	Piston rod									
	Cylinder barrel									
Cushioning	Flexible cushioning rings/plates at both ends									
Position sensing	For proximity sensing									
Type of mounting	Via through-holes									
	With female thread									
	Via accessories									
Mounting position	Any									

Operating pressure [bar]										
Piston Ø	12	16	20	25	32	40	50	63	80	100
Piston rod at one end	1.5 ... 10			1.0 ... 10						
Through piston rod S2	1.5 ... 10				1.0 ... 10					

Ambient conditions				
Compact cylinder	Basic version		S6	CT
Ambient temperature ¹⁾ [°C]	-20 ... +80		0 ... +120	-5 ... +60
Corrosion resistance class CRC ²⁾	2		2	2

1) Note operating range of proximity sensors

2) Corrosion resistance class 2 according to Festo standard 940 070

Components requiring moderate corrosion resistance. Externally visible parts with primarily decorative surface requirements which are in direct contact with a surrounding industrial atmosphere or media such as cooling or lubricating agents

Compact cylinders ADVUL

Technical data

FESTO

Forces [N] and impact energy [J]										
Piston Ø	12	16	20	25	32	40	50	63	80	100
Theoretical force at 6 bar, advancing	68	121	188	295	483	754	1 178	1 870	3 016	4 712
S2	51	90	141	247	415	686	1 057	1 750	2 827	4 418
Theoretical force at 6 bar, retracting	51	90	141	247	415	686	1 057	1 750	2 827	4 418
S2	51	90	141	247	415	686	1 057	1 750	2 827	4 418
Max. impact energy at end positions	0.09	0.10	0.14	0.10	0.40	0.52	0.64	0.70	0.75	1.00

Max. lateral force F_q as a function of projection x

Piston rod at one end

Through piston rod

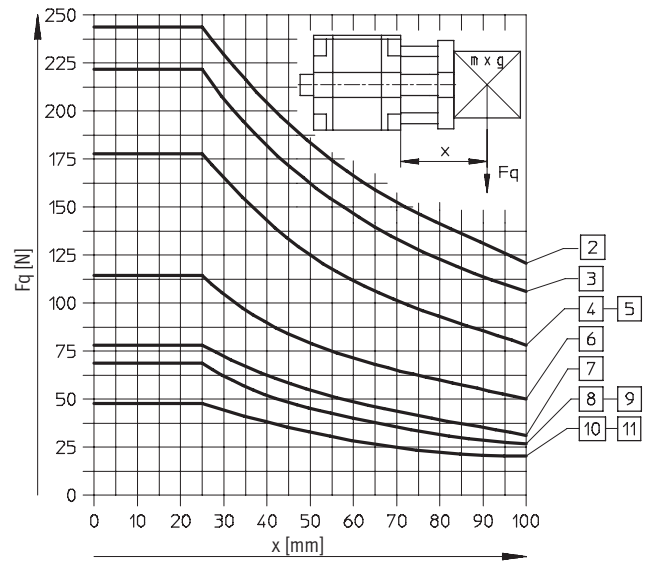
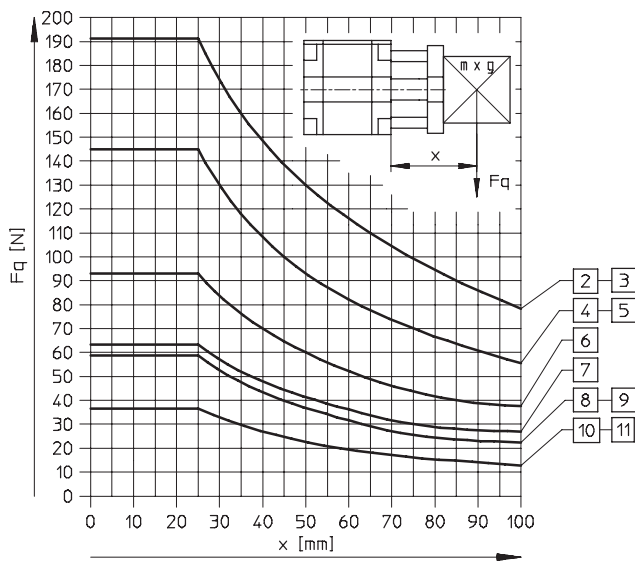

- 2 Ø 100 mm
- 3 Ø 80 mm
- 4 Ø 63 mm

- 5 Ø 50 mm
- 6 Ø 40 mm
- 7 Ø 32 mm

- 8 Ø 25 mm
- 9 Ø 20 mm
- 10 Ø 16 mm

- 11 Ø 12 mm

Torque M in relation to stroke length L

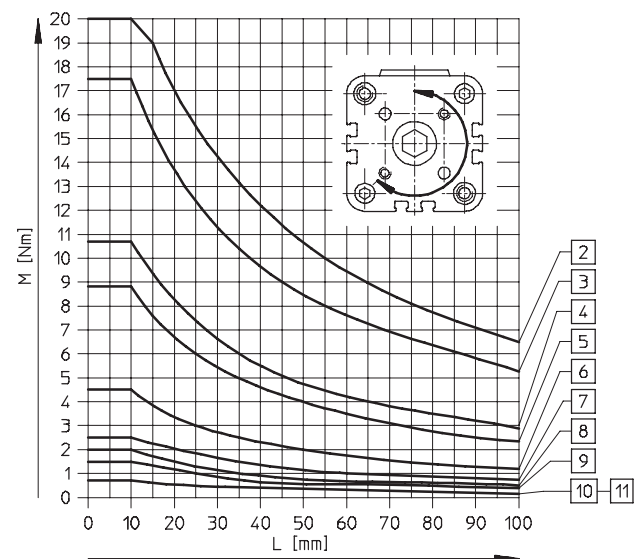

- 2 Ø 100 mm
- 3 Ø 80 mm
- 4 Ø 63 mm
- 5 Ø 50 mm
- 6 Ø 40 mm

- 7 Ø 32 mm
- 8 Ø 25 mm
- 9 Ø 20 mm
- 10 Ø 16 mm
- 11 Ø 12 mm

Compact cylinders ADVUL

Technical data

FESTO

Materials

Sectional view

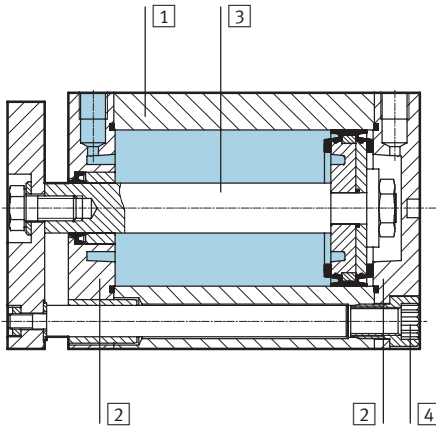

Compact cylinder	Basic version	S6	CT
1 Cylinder barrel	Wrought aluminium alloy	Wrought aluminium alloy	Wrought aluminium alloy
2 Bearing and end cap	Wrought aluminium alloy	Wrought aluminium alloy	Wrought aluminium alloy
3 Piston rod	∅ 12 ... 32	High-alloy stainless steel	High-alloy stainless steel
	∅ 40 ... 100	High-alloy steel	High-alloy steel
4 Flange screws	∅ 12 ... 16	High-alloy stainless steel	High-alloy stainless steel
	∅ 20 ... 100	Tempered steel	Tempered steel
- Seals	Polyurethane, nitrile rubber	Fluorocautchouc	Polyurethane, nitrile rubber

Compact cylinders ADVUL

Technical data

FESTO

Dimensions – Basic cylinders

Download CAD data → www.festo.com

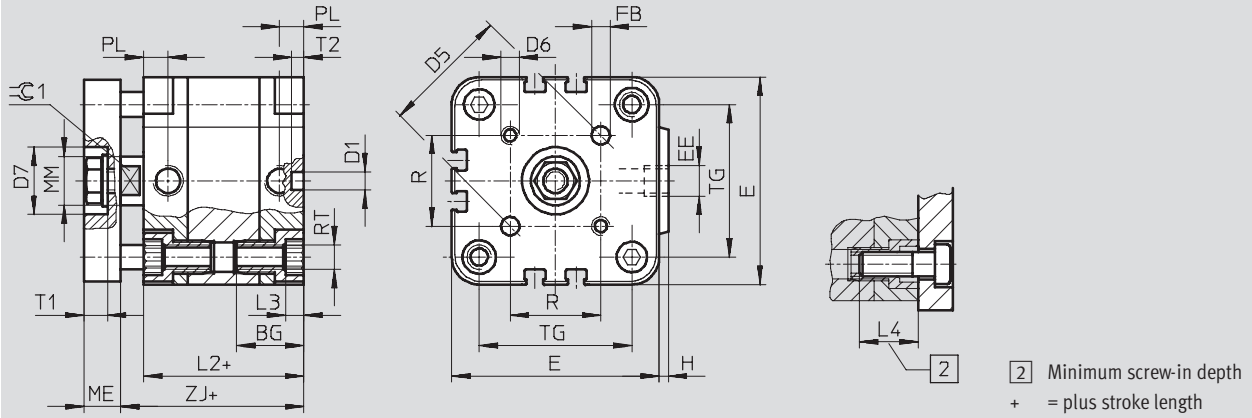

∅ [mm]	BG ¹⁾	D1 ∅ H9	D5	D6	D7 ∅ H9	E	EE	FB ∅ H8	H	L2	L3
12	18.5	6	14	M3	–	29	M5	3	1	38	3
16	18.5	6	14	M3	–	29	M5	3	1	38	3
20	18.5	6	17	M4	–	36	M5	4	1.5	38	4
25	18.5	6	22	M5	14	40	M5	5	1.5	39.5	4
32	21.5	6	28	M5	17	50	G ¹ / ₈	5	2	44.5	5
40	21.5	6	33	M5	17	60	G ¹ / ₈	5	2.5	45.5	5
50	22	6	42	M6	22	68	G ¹ / ₈	6	3	45.5	6
63	24.5	8	50	M6	22	87	G ¹ / ₈	6	4	50	8
80	27.5	8	65	M8	28	107	G ¹ / ₈	8	4	56	8
100	32.5	8	80	M10	30	128	G ¹ / ₄	10	5	66.5	8

∅ [mm]	L4	ME	MM ∅	PL	R	RT	T1 +0.2	T2 –0.2	TG	∅C1 h13
12	16	6	6	8	9.9	M4	–	4	18	5
16	16	6	8	8	9.9	M4	–	4	18	7
20	18	8	10	8	12	M5	–	4	22	9
25	18	8	10	8	15.6	M5	4.8	4	26	9
32	20	10	12	8	19.8	M6	6.1	4	32	10
40	20	10	12	8	23.3	M6	6.1	4	42	10
50	20	12	16	8	29.7	M8	7.6	4	50	13
63	25	12	16	8	35.4	M10	7.6	4	62	13
80	25	14	20	8.5	46	M10	8.7	4	82	17
100	25	14	25	10.5	56.6	M10	10.3	4	103	22

1) Do not exceed screw-in depth

Compact cylinders ADVUL

Technical data

FESTO

Dimensions – Variants

Download CAD data → www.festo.com

Piston rod at one end

Through piston rod

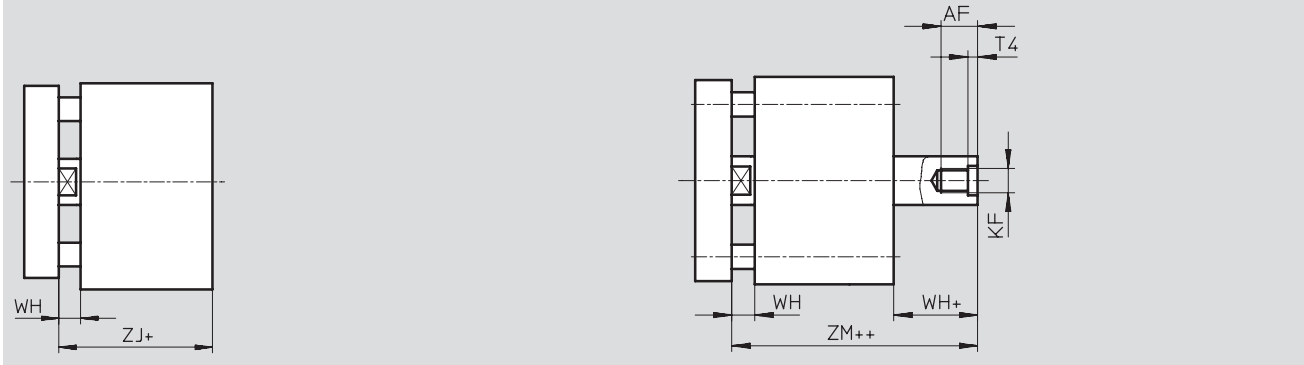

∅	AF	KF	T4	WH	ZJ	ZM
[mm]						
12	8	M3	1.5	4.5	42.5	47
16	10	M4	1.5	4.5	42.5	47
20	12	M5	2	4.5	42.5	47
25	12	M5	2	5.5	45	50.5
32	14	M6	2.6	6	50.5	56.5
40	14	M6	2.6	6.5	52	58.5
50	16	M8	3.3	7.5	53	60.5
63	16	M8	3.3	7.5	57.5	65
80	20 ¹⁾	M10	4.7	8	64	72
100	24 ¹⁾	M12	6.1	10	76.5	86.5

1) With a stroke < 5 mm, the maximum screw-in depth is reduced by 5 mm

Compact cylinders ADVUL

Technical data

FESTO



Ordering data – Basic version						
Type	Stroke [mm]	Part No.	Type	Stroke [mm]	Part No.	Type
	Piston Ø 12 mm			Piston Ø 16 mm		
	5	156 844	ADVUL-12-5-P-A	5	156 851	ADVUL-16-5-P-A
	10	156 845	ADVUL-12-10-P-A	10	156 852	ADVUL-16-10-P-A
	15	156 846	ADVUL-12-15-P-A	15	156 853	ADVUL-16-15-P-A
	20	156 847	ADVUL-12-20-P-A	20	156 854	ADVUL-16-20-P-A
	25	156 848	ADVUL-12-25-P-A	25	156 855	ADVUL-16-25-P-A
	30	156 849	ADVUL-12-30-P-A	30	156 856	ADVUL-16-30-P-A
	40	156 850	ADVUL-12-40-P-A	40	156 857	ADVUL-16-40-P-A
	Piston Ø 20 mm			Piston Ø 25 mm		
	5	156 858	ADVUL-20-5-P-A	5	156 866	ADVUL-25-5-P-A
	10	156 859	ADVUL-20-10-P-A	10	156 867	ADVUL-25-10-P-A
	15	156 860	ADVUL-20-15-P-A	15	156 868	ADVUL-25-15-P-A
	20	156 861	ADVUL-20-20-P-A	20	156 869	ADVUL-25-20-P-A
	25	156 862	ADVUL-20-25-P-A	25	156 870	ADVUL-25-25-P-A
	30	156 863	ADVUL-20-30-P-A	30	156 871	ADVUL-25-30-P-A
	40	156 864	ADVUL-20-40-P-A	40	156 872	ADVUL-25-40-P-A
	50	156 865	ADVUL-20-50-P-A	50	156 873	ADVUL-25-50-P-A
	Piston Ø 32 mm			Piston Ø 40 mm		
	5	156 874	ADVUL-32-5-P-A	5	156 884	ADVUL-40-5-P-A
	10	156 875	ADVUL-32-10-P-A	10	156 885	ADVUL-40-10-P-A
	15	156 876	ADVUL-32-15-P-A	15	156 886	ADVUL-40-15-P-A
	20	156 877	ADVUL-32-20-P-A	20	156 887	ADVUL-40-20-P-A
	25	156 878	ADVUL-32-25-P-A	25	156 888	ADVUL-40-25-P-A
	30	156 879	ADVUL-32-30-P-A	30	156 889	ADVUL-40-30-P-A
	40	156 880	ADVUL-32-40-P-A	40	156 890	ADVUL-40-40-P-A
	50	156 881	ADVUL-32-50-P-A	50	156 891	ADVUL-40-50-P-A
	60	156 882	ADVUL-32-60-P-A	60	156 892	ADVUL-40-60-P-A
	80	156 883	ADVUL-32-80-P-A	80	156 893	ADVUL-40-80-P-A
	Piston Ø 50 mm			Piston Ø 63 mm		
	10	156 894	ADVUL-50-10-P-A	10	156 903	ADVUL-63-10-P-A
	15	156 895	ADVUL-50-15-P-A	15	156 904	ADVUL-63-15-P-A
	20	156 896	ADVUL-50-20-P-A	20	156 905	ADVUL-63-20-P-A
	25	156 897	ADVUL-50-25-P-A	25	156 906	ADVUL-63-25-P-A
	30	156 898	ADVUL-50-30-P-A	30	156 907	ADVUL-63-30-P-A
	40	156 899	ADVUL-50-40-P-A	40	156 908	ADVUL-63-40-P-A
	50	156 900	ADVUL-50-50-P-A	50	156 909	ADVUL-63-50-P-A
	60	156 901	ADVUL-50-60-P-A	60	156 910	ADVUL-63-60-P-A
	80	156 902	ADVUL-50-80-P-A	80	156 911	ADVUL-63-80-P-A
	Piston Ø 80 mm			Piston Ø 100 mm		
	10	156 912	ADVUL-80-10-P-A	10	156 921	ADVUL-100-10-P-A
	15	156 913	ADVUL-80-15-P-A	15	156 922	ADVUL-100-15-P-A
	20	156 914	ADVUL-80-20-P-A	20	156 923	ADVUL-100-20-P-A
	25	156 915	ADVUL-80-25-P-A	25	156 924	ADVUL-100-25-P-A
	30	156 916	ADVUL-80-30-P-A	30	156 925	ADVUL-100-30-P-A
	40	156 917	ADVUL-80-40-P-A	40	156 926	ADVUL-100-40-P-A
	50	156 918	ADVUL-80-50-P-A	50	156 927	ADVUL-100-50-P-A
	60	156 919	ADVUL-80-60-P-A	60	156 928	ADVUL-100-60-P-A
	80	156 920	ADVUL-80-80-P-A	80	156 929	ADVUL-100-80-P-A

Compact cylinders ADVUL

Technical data

FESTO



Ordering data – CT with fixed stroke						
Type	Stroke [mm]	Part No.	Type	Stroke [mm]	Part No.	Type
	Piston Ø 12 mm			Piston Ø 16 mm		
	5	183 383	ADVUL-12-5-P-A-CT	5	183 388	ADVUL-16-5-P-A-CT
	10	183 384	ADVUL-12-10-P-A-CT	10	183 389	ADVUL-16-10-P-A-CT
	15	183 385	ADVUL-12-15-P-A-CT	15	183 390	ADVUL-16-15-P-A-CT
	20	183 386	ADVUL-12-20-P-A-CT	20	183 391	ADVUL-16-20-P-A-CT
	Piston Ø 20 mm			Piston Ø 25 mm		
	5	183 393	ADVUL-20-5-P-A-CT	5	183 398	ADVUL-25-5-P-A-CT
	10	183 394	ADVUL-20-10-P-A-CT	10	183 399	ADVUL-25-10-P-A-CT
	15	183 395	ADVUL-20-15-P-A-CT	15	183 400	ADVUL-25-15-P-A-CT
	20	183 396	ADVUL-20-20-P-A-CT	20	183 401	ADVUL-25-20-P-A-CT
	Piston Ø 32 mm			Piston Ø 40 mm		
	5	183 403	ADVUL-32-5-P-A-CT	5	183 408	ADVUL-40-5-P-A-CT
	10	183 404	ADVUL-32-10-P-A-CT	10	183 409	ADVUL-40-10-P-A-CT
	15	183 405	ADVUL-32-15-P-A-CT	15	183 410	ADVUL-40-15-P-A-CT
	20	183 406	ADVUL-32-20-P-A-CT	20	183 411	ADVUL-40-20-P-A-CT

Ordering data – Variants				
Type	Piston Ø [mm]	Stroke [mm]	Part No.	Type
Variable stroke				
	12	1 ... 200	156 200	ADVUL-12-...-P-A
	16	1 ... 200	156 201	ADVUL-16-...-P-A
	20	1 ... 200	156 202	ADVUL-20-...-P-A
	25	1 ... 200	156 203	ADVUL-25-...-P-A
	32	1 ... 300	156 204	ADVUL-32-...-P-A
	40	1 ... 300	156 205	ADVUL-40-...-P-A
	50	1 ... 300	156 206	ADVUL-50-...-P-A
	63	1 ... 300	156 207	ADVUL-63-...-P-A
	80	1 ... 400	156 208	ADVUL-80-...-P-A
	100	1 ... 400	156 209	ADVUL-100-...-P-A
S2 – Through piston rod, variable stroke				
	12	1 ... 200	165 089	ADVUL-12-...-P-A-S2
	16	1 ... 200	165 090	ADVUL-16-...-P-A-S2
	20	1 ... 200	165 091	ADVUL-20-...-P-A-S2
	25	1 ... 200	165 092	ADVUL-25-...-P-A-S2
	32	1 ... 300	165 093	ADVUL-32-...-P-A-S2
	40	1 ... 300	165 094	ADVUL-40-...-P-A-S2
	50	1 ... 300	165 095	ADVUL-50-...-P-A-S2
	63	1 ... 300	165 096	ADVUL-63-...-P-A-S2
	80	1 ... 400	165 097	ADVUL-80-...-P-A-S2
	100	1 ... 400	165 098	ADVUL-100-...-P-A-S2

Compact cylinders ADVUL

Technical data

FESTO

Ordering data – Variants				
Type	Piston Ø [mm]	Stroke [mm]	Part No.	Type
S6 – Heat-resistant up to 120 °C, variable stroke				
	12	1 ... 200	156 210	ADVUL-12-...-P-A-S6
	16	1 ... 200	156 211	ADVUL-16-...-P-A-S6
	20	1 ... 200	156 212	ADVUL-20-...-P-A-S6
	25	1 ... 200	156 213	ADVUL-25-...-P-A-S6
	32	1 ... 300	156 214	ADVUL-32-...-P-A-S6
	40	1 ... 300	156 215	ADVUL-40-...-P-A-S6
	50	1 ... 300	156 216	ADVUL-50-...-P-A-S6
	63	1 ... 300	156 217	ADVUL-63-...-P-A-S6
	80	1 ... 400	156 218	ADVUL-80-...-P-A-S6
	100	1 ... 400	156 219	ADVUL-100-...-P-A-S6
CT – Free of copper, PTFE and silicone, variable stroke				
	12	1 ... 200	183 382	ADVUL-12-...-P-A-CT
	16	1 ... 200	183 387	ADVUL-16-...-P-A-CT
	20	1 ... 200	183 392	ADVUL-20-...-P-A-CT
	25	1 ... 200	183 397	ADVUL-25-...-P-A-CT
	32	1 ... 300	183 402	ADVUL-32-...-P-A-CT
	40	1 ... 300	183 407	ADVUL-40-...-P-A-CT

Ordering data – Wearing parts kits				
	Part No.	Type	Part No.	Type
Piston Ø	Basic version		S6 – Heat-resistant up to 120 °C	
12	121 115	ADVUL-12-...-P-A ¹⁾	383 559	ADVUL-12-...-P-A-S6 ²⁾
16	121 116	ADVUL-16-...-P-A ¹⁾	383 560	ADVUL-16-...-P-A-S6 ²⁾
20	121 117	ADVUL-20-...-P-A ¹⁾	383 561	ADVUL-20-...-P-A-S6 ²⁾
25	121 118	ADVUL-25-...-P-A ¹⁾	383 562	ADVUL-25-...-P-A-S6 ²⁾
32	121 119	ADVUL-32-...-P-A ¹⁾	383 563	ADVUL-32-...-P-A-S6 ¹⁾
40	121 120	ADVUL-40-...-P-A ¹⁾	383 564	ADVUL-40-...-P-A-S6 ¹⁾
50	121 121	ADVUL-50-...-P-A ¹⁾	383 565	ADVUL-50-...-P-A-S6 ¹⁾
63	121 122	ADVUL-63-...-P-A ¹⁾	383 566	ADVUL-63-...-P-A-S6 ¹⁾
80	121 123	ADVUL-80-...-P-A ¹⁾	383 567	ADVUL-80-...-P-A-S6 ¹⁾
100	121 124	ADVUL-100-...-P-A ¹⁾	383 568	ADVUL-100-...-P-A-S6 ¹⁾

1) Assembly grease included in scope of delivery

2) Assembly grease not included in scope of delivery. If required, please order separately under part no. 329 555 (20 ml)

Compact cylinders ADVUL

Accessories

FESTO

Flange mounting FUA

Material:
Clear anodised aluminium

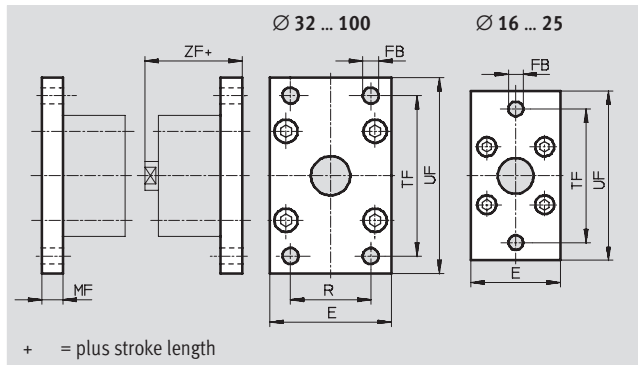

Dimensions and ordering data											
For Ø	E	FB Ø	MF	R	TF	UF	ZF	CRC ¹⁾	Weight	Part No.	Type
[mm]									[g]		
12/16	29	5.5	10	–	43	55	52.5	2	48	157 299	FUA-12/16
20	36	6.6	10	–	55	70	52.5	2	72	157 300	FUA-20
25	40	6.6	10	–	60	76	55	2	87	157 301	FUA-25
32	50	7	10	32	65	80	60.5	2	117	157 302	FUA-32
40	60	9	10	36	82	102	62	2	180	157 303	FUA-40
50	68	9	12	45	90	110	65	2	266	157 304	FUA-50
63	87	9	15	50	110	130	72.5	2	550	157 305	FUA-63
80	107	12	15	63	135	160	76	2	745	157 306	FUA-80
100	128	14	15	75	163	190	91.5	2	1.035	157 307	FUA-100

1) Corrosion resistance class 2 according to Festo standard 940 070
Components requiring moderate corrosion resistance. Externally visible parts with primarily decorative surface requirements which are in direct contact with a surrounding industrial atmosphere or media such as cooling or lubricating agents

Compact cylinders ADVUL

Accessories

FESTO

Swivel flange SUA for piston \varnothing 12 ... 25 mm

Material:
Anodised aluminium
Free of copper, PTFE and silicone



\varnothing 12 ... 25 mm

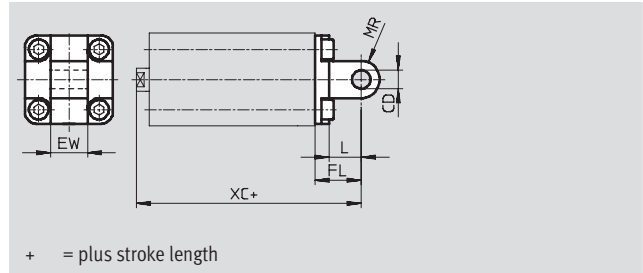

+ = plus stroke length

for piston \varnothing 32 ... 100 mm

Material:
Anodised aluminium
Free of copper, PTFE and silicone

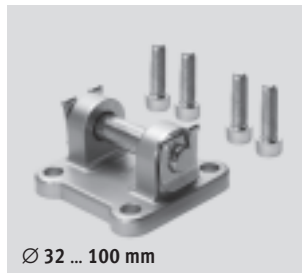

\varnothing 32 ... 100 mm

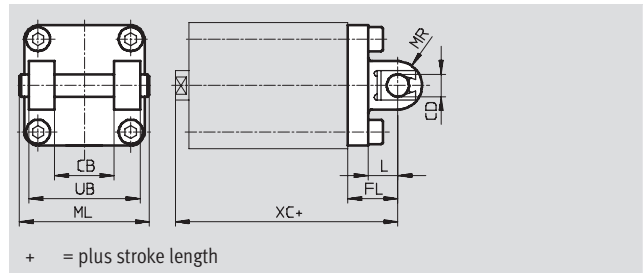

+ = plus stroke length

Dimensions and ordering data												
For \varnothing	CB	CD	EW	FL	L	ML	MR	UB	XC	Weight	Part No.	Type
[mm]		\varnothing								[g]		
12/16	–	6	12	16	10	–	6	–	58.5	43	157 319	SUA-12/16
20	–	8	16	20	14	–	8	–	62.5	78	157 320	SUA-20
25	–	8	16	20	14	–	8	–	64	86	157 321	SUA-25
32	26	10	–	22	13	54	10	45	72.5	208	157 322	SUA-32
40	28	12	–	25	16	62	12	52	77	320	157 323	SUA-40
50	32	12	–	27	16	70	12	60	80	437	157 324	SUA-50
63	40	16	–	32	21	82	16	70	89.5	760	157 325	SUA-63
80	50	16	–	36	23	102	16	90	100	1 190	157 326	SUA-80
100	60	20	–	41	26	126	20	110	117.5	1 900	157 327	SUA-100

 Note
The maximum stroke length may not be exceeded when combining cylinders and swivel flanges.

For \varnothing	Max. stroke length [mm]
12	50
16	50
20	50
25	50
32	100

For \varnothing	Max. stroke length [mm]
40	100
50	100
63	100
80	150
100	150

Compact cylinders ADVUL

Accessories

FESTO

Adapter kit DPVU

Material:
Aluminium
Free of copper, PTFE and silicone

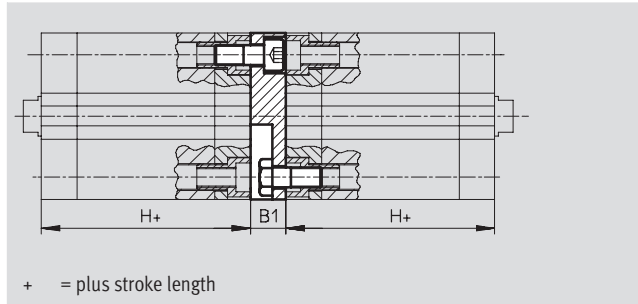

Dimensions and ordering data							
For Ø	B1	H	Max. overall stroke length	CRC ¹⁾	Weight	Part No.	Type
[mm]			[mm]		[g]		
12/16	12.5	38	400	2	22	161 194	DPVU-12/16
20	12.5	38	400	2	36	161 195	DPVU-20
25	13	39.5	400	2	44	161 196	DPVU-25
32	14.5	44.5	600	2	90	161 197	DPVU-32
40	14.5	45.5	600	2	137	161 198	DPVU-40
50	14.5	45.5	600	2	177	161 199	DPVU-50
63	14.5	50	600	2	308	161 200	DPVU-63
80	16.5	56	800	2	495	161 201	DPVU-80
100	19.5	66.5	800	2	859	161 202	DPVU-100

 **Note**
The maximum overall stroke length may not be exceeded when combining cylinders and the multi-position adapter kit.

1) Corrosion resistance class 2 according to Festo standard 940 070
Components requiring moderate corrosion resistance. Externally visible parts with primarily decorative surface requirements which are in direct contact with a surrounding industrial atmosphere or media such as cooling or lubricating agents

Connecting two cylinders with identical piston diameter as a 3 or 4-position cylinder

A 3 or 4-position cylinder consists of two separate cylinders whose piston rods advance in opposing directions.

Depending upon actuation and stroke pattern, this type of cylinder can assume up to four positions. In each

case the cylinder is driven precisely against a stop. If one end of the piston rod is fixed, the cylinder barrel

executes the movement. The cylinder must be connected with flexible line connections.

Implementing 3 positions

Two cylinders with identical stroke length must be connected to this end.

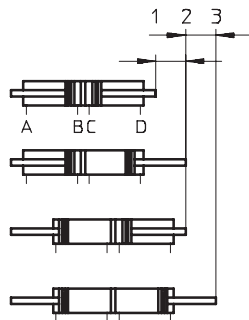

Implementing 4 positions

Two cylinders with different stroke lengths must be connected to this end.

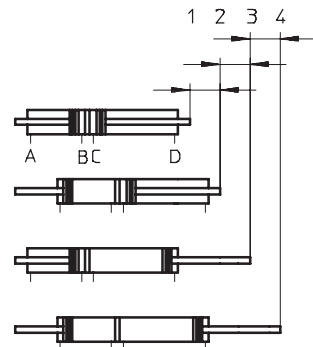

Compact cylinders ADVUL

Accessories

FESTO

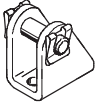
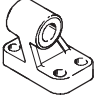
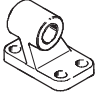
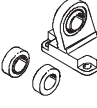
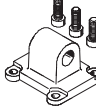

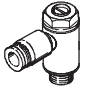
Ordering data – Mounting attachments				Technical data → Internet: mounting attachment				
Designation	For Ø	Part No.	Type	Designation	For Ø	Part No.	Type	
Clevis foot LBN				Clevis foot LNG				
	12	6 058	LBN-12/16		32	33 890	LNG-32	
	16	6 058	LBN-12/16		40	33 891	LNG-40	
	20	6 059	LBN-20/25		50	33 892	LNG-50	
	25	6 059	LBN-20/25		63	33 893	LNG-63	
			80		33 894	LNG-80		
			100		33 895	LNG-100		
Clevis foot LN				Clevis foot LSN				
	32	5 147	LN-32		32	5 561	LSN-32	
	40	5 148	LN-40		40	5 562	LSN-40	
	50	5 149	LN-50		50	5 563	LSN-50	
	63	5 150	LN-63		63	5 564	LSN-63	
	80	5 151	LN-80		80	5 565	LSN-80	
	100	5 152	LN-100		100	5 566	LSN-100	
Swivel flange SNCL								
	32	174 404	SNCL-32					
	40	174 405	SNCL-40					
	50	174 406	SNCL-50					
	63	174 407	SNCL-63					
	80	174 408	SNCL-80					
	100	174 409	SNCL-100					



Ordering data – One-way flow control valves				Technical data → Internet: grla	
	Connection		Material	Part No.	Type
	Thread	For tubing O.D.			
	M5	3	Metal design	193 137	GRLA-M5-QS-3-D
		4		193 138	GRLA-M5-QS-4-D
		6		193 139	GRLA-M5-QS-6-D
	G ¹ / ₈	3		193 142	GRLA- ¹ / ₈ -QS-3-D
		4		193 143	GRLA- ¹ / ₈ -QS-4-D
		6		193 144	GRLA- ¹ / ₈ -QS-6-D
		8		193 145	GRLA- ¹ / ₈ -QS-8-D
		10		193 146	GRLA- ¹ / ₈ -QS-10-D
	G ¹ / ₄	6		193 147	GRLA- ¹ / ₄ -QS-6-D
		8		193 148	GRLA- ¹ / ₄ -QS-8-D
		10			

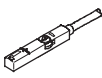

Compact cylinders ADVUL

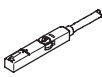
Accessories

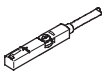
FESTO

Ordering data – Proximity sensors for T-slot, magneto-resistive						Technical data → Internet: smt
	Type of mounting	Switch output	Electrical connection	Cable length [m]	Part No.	Type
N/O contact						
	Insertable in the slot from above, flush with cylinder profile	PNP	Cable, 3-wire	2.5	543 867	SMT-8M-PS-24V-K-2,5-OE
			Plug M8x1, 3-pin	0.3	543 866	SMT-8M-PS-24V-K-0,3-M8D
			Plug M12x1, 3-pin	0.3	543 869	SMT-8M-PS-24V-K-0,3-M12
		NPN	Cable, 3-wire	2.5	543 870	SMT-8M-NS-24V-K-2,5-OE
			Plug M8x1, 3-pin	0.3	543 871	SMT-8M-NS-24V-K-0,3-M8D
			Plug M12x1, 3-pin	0.3	543 872	SMT-8M-NS-24V-K-0,3-M12
	Insertable in the slot lengthwise, flush with the cylinder profile	PNP	Cable, 3-wire	2.5	175 436	SMT-8-PS-K-LED-24-B
			Plug M8x1, 3-pin	0.3	175 484	SMT-8-PS-S-LED-24-B
N/C contact						
	Insertable in the slot from above, flush with cylinder profile	PNP	Cable, 3-wire	7.5	543 873	SMT-8M-PO-24V-K7,5-OE

Ordering data – Proximity sensors for T-slot, magnetic reed						Technical data → Internet: sme
	Type of mounting	Switch output	Electrical connection	Cable length [m]	Part No.	Type
N/O contact						
	Insertable in the slot from above, flush with cylinder profile	Contacting	Cable, 3-wire	2.5	543 862	SME-8M-DS-24V-K-2,5-OE
				5.0	543 863	SME-8M-DS-24V-K-5,0-OE
			Plug M8x1, 3-pin	2.5	543 872	SME-8M-ZS-24V-K-2,5-OE
				0.3	543 861	SME-8M-DS-24V-K-0,3-M8D
	Insertable in the slot lengthwise, flush with the cylinder profile	Contacting	Cable, 3-wire	2.5	150 855	SME-8-K-LED-24
			Plug M8x1, 3-pin	0.3	150 857	SME-8-S-LED-24
N/C contact						
	Insertable in the slot lengthwise, flush with the cylinder profile	Contacting	Cable, 3-wire	7.5	160 251	SME-8-O-K-LED-24

Ordering data – Connecting cables					Technical data → Internet: nebu
	Electrical connection, left	Electrical connection, right	Cable length [m]	Part No.	Type
	Straight socket, M8x1, 3-pin	Cable, open end, 3-wire	2.5	541 333	NEBU-M8G3-K-2.5-LE3
			5	541 334	NEBU-M8G3-K-5-LE3
	Straight socket, M12x1, 5-pin	Cable, open end, 3-wire	2.5	541 363	NEBU-M12G5-K-2.5-LE3
			5	541 364	NEBU-M12G5-K-5-LE3
	Angled socket, M8x1, 3-pin	Cable, open end, 3-wire	2.5	541 338	NEBU-M8W3-K-2.5-LE3
			5	541 341	NEBU-M8W3-K-5-LE3
	Angled socket, M12x1, 5-pin	Cable, open end, 3-wire	2.5	541 367	NEBU-M12W5-K-2.5-LE3
			5	541 370	NEBU-M12W5-K-5-LE3

Ordering data – Slot cover for T-slot				
	Mounting	Length	Part No.	Type
	Insertable from above	2x 0.5 m	151 680	ABP-5-S